



SAMSUNG SPS 1000

PROGRAM MANUAL



CONTENTS

GETTING STARTED

REGISTER CONTROLS – DISPLAY	13
FRONT VIEW	13
DISPLAY ADJUSTMENTS	13
REAR VIEW	13
REGISTER CONTROLS – MODE LOCK	14
MODE LOCK	14
DEFAULT KEYBOARD	16
Essential Function Keys	16
ALPHA OVERLAY KEYBOARD	17
ALPHA CODE PROGRAMMING	18
DISPLAY OPERATION – PAGE MOVEMENT	20
DISPLAY OPERATION – FIELD SELECTION	21
DISPLAY OPERATION – POP UP WINDOWS	22
DISPLAY MESSAGES	25
DISPLAY MESSAGES	26
DISPLAY MESSAGES	27
DISPLAY MESSAGES	28
DISPLAY MESSAGES	29
DISPLAY MESSAGES	30
DISPLAY MESSAGES	31
DISPLAY MESSAGES	32
DISPLAY MESSAGES	33
DISPLAY MESSAGES	34
DISPLAY MESSAGES	35
DISPLAY MESSAGES	36
DISPLAY MESSAGES	37
DISPLAY MESSAGES	38
ERROR CLEAR INIT PROCEDURE	40
KEYBOARD CLEAR PROCEDURE	41
PROGRAM RESET	45
MEMORY ALLOCATION	46
MEMORY ALLOCATION - DEFINITIONS	47
MEMORY ALLOCATION - DEFINITIONS	48
MEMORY ALLOCATION - DEFINITIONS	49
MEMORY ALLOCATION - DEFINITIONS	49
SELF TESTS	52
SELF TESTS - DEFINITIONS	53
MEMORY CLEAR	54
MEMORY CLEAR - DEFINITIONS	55
KEYBOARD KEY RELOCATION	56
KEYBOARD KEY RELOCATION - DEFINITIONS	57
FUNCTION KEY – LISTING	58
FUNCTION KEY – LISTING	59
FUNCTION KEY – LISTING	60
FUNCTION KEY - DEFINITIONS	61

FUNCTION KEY - DEFINITIONS 62
 FUNCTION KEY - DEFINITIONS 63
 FUNCTION KEY - DEFINITIONS 64
 FUNCTION KEY - DEFINITIONS 65
 FUNCTION KEY - DEFINITIONS 66
 FUNCTION KEY - DEFINITIONS 67
 FUNCTION KEY - DEFINITIONS 68
 FUNCTION KEY - DEFINITIONS 69
 FUNCTION KEY - DEFINITIONS 70
 FUNCTION KEY - DEFINITIONS 71
 S-MODE SYSTEM OPTIONS..... 73
 S-MODE SYSTEM OPTIONS – DEFINITIONS 74
 PRINTER DRIVER SELECTIONS..... 75
 PRINTER DRIVER DEFINITIONS..... 76
 SERIAL PORT DEVICE SELECTIONS 77
 SERIAL PORT SELECTIONS - DEFINITIONS 78
 DEFINE SERIAL PORT PARAMETERS..... 79
 SERIAL PORT PARAMETERS - DEFINITIONS 80
 S-MODE PROGRAM SCANS..... 81
 S-MODE PROGRAM SCANS..... 82
 SYSTEM PASSWORD 83
 SUPER MACRO SCAN 84
 ROM FILE DOWNLOAD..... 85
 ROM FILE DOWNLOAD..... 86
 LOAD DEFAULT MESSAGES..... 87
 DEFAULT ERROR MESSAGES 88
 DEFAULT ERROR MESSAGES 89
 DEFAULT SYSTEM DESCRIPTORS..... 90
 UNLOCK PROCEDURES..... 91
 PLU – PROGRAMMING 94
 PLU – DEFINITIONS 95
 PLU – DEFINITIONS 96
 PLU STATUS GROUP – PROGRAMMING..... 97
 PLU STATUS GROUP – DEFINITIONS..... 98
 PLU STATUS GROUP – DEFINITIONS..... 99
 PLU STATUS GROUP – DEFINITIONS..... 100
 GROUP – PROGRAMMING..... 102
 GROUP – DEFINITIONS..... 103
 FUNCTION KEY – PROGRAMMING 104
 FUNCTION KEY – LISTING 105
 FUNCTION KEY – LISTING 106
 FUNCTION KEY – LISTING 107
 FUNCTION KEY - DEFINITIONS 108
 FUNCTION KEY - DEFINITIONS 109
 FUNCTION KEY - DEFINITIONS 110
 FUNCTION KEY - DEFINITIONS 110

FUNCTION KEY - DEFINITIONS	111
FUNCTION KEY - DEFINITIONS	112
FUNCTION KEY - DEFINITIONS	113
FUNCTION KEY - DEFINITIONS	115
FUNCTION KEY - DEFINITIONS	116
FUNCTION KEY - DEFINITIONS	116
FUNCTION KEY - DEFINITIONS	118
FUNCTION KEY - DEFINITIONS	119
FUNCTION KEY - DEFINITIONS	120
FUNCTION KEY - DEFINITIONS	121
FUNCTION KEY - DEFINITIONS	122
FUNCTION KEY - DEFINITIONS	123
sSYSTEM OPTIONs.....	124
SYSTEM OPTION – DEFINITIONS.....	125
GENERAL FUNCTION OPTIONS.....	125
SYSTEM OPTION – DEFINITIONS.....	126
GENERAL FUNCTION OPTIONS.....	126
SYSTEM OPTION – DEFINITIONS.....	127
GENERAL FUNCTION OPTIONS.....	127
SYSTEM OPTION – DEFINITIONS.....	129
GENERAL FUNCTION OPTIONS.....	129
SYSTEM OPTION – DEFINITIONS.....	130
GENERAL FUNCTION OPTIONS.....	130
SYSTEM OPTION – DEFINITIONS.....	131
TAX OPTIONS.....	131
SYSTEM OPTION – DEFINITIONS.....	132
CASH DRAWER OPTIONS.....	132
SYSTEM OPTION – DEFINITIONS.....	133
TRAINING MODE OPTIONS.....	133
SYSTEM OPTION – DEFINITIONS.....	134
LEVEL/MODIFIER OPTIONS.....	134
SYSTEM OPTION – DEFINITIONS.....	135
TRACKING FILE OPTIONS	135
SYSTEM OPTION – DEFINITIONS.....	136
TRACKING FILE OPTIONS	136
SYSTEM OPTION – DEFINITIONS.....	137
KITCHEN PRINTING/VIDEO OPTIONS	137
SYSTEM OPTION – DEFINITIONS.....	138
KITCHEN PRINTING/VIDEO OPTIONS	138
SYSTEM OPTION – DEFINITIONS.....	139
VALIDATION/SUBTOTAL OPTIONS	139
SYSTEM OPTION – DEFINITIONS.....	140
GENERAL PRINTING OPTIONS	140
SYSTEM OPTION – DEFINITIONS.....	141
GENERAL PRINTING OPTIONS	141
SYSTEM OPTION – DEFINITIONS.....	142
GENERAL PRINTING OPTIONS	142
SYSTEM OPTION – DEFINITIONS.....	143
GENERAL PRINTING OPTIONS	143
SYSTEM OPTION – DEFINITIONS.....	144

REPORT PRINTING OPTIONS	144
SYSTEM OPTION – DEFINITIONS.....	145
REPORT OPTIONS.....	145
SYSTEM OPTION – DEFINITIONS.....	146
REPORT OPTIONS.....	146
SYSTEM OPTION – DEFINITIONS.....	147
TIME KEEPING OPTIONS	147
SYSTEM OPTION – DEFINITIONS.....	148
E.J. & Detail PRINTING OPTIONS.....	148
TAX.....	149
MESSAGES.....	150
DEFAULT ERROR MESSAGES	151
DEFAULT ERROR MESSAGES	152
DEFAULT SYSTEM DESCRIPTORS.....	153
WLU – WINDOW LOOK UP.....	155
WLU – WINDOW LOOK UP DEFINITIONS	156
TIME PERIOD	157
EMPLOYEE	160
EMPLOYEE - DEFINITIONS	161
JOB CODE PROGRAM.....	161
PAY RATE PROGRAM.....	161
AUTHORITY	162
AUTHORITY – DEFINITIONS	163
AUTHORITY – DEFINITIONS	164
AUTHORITY – DEFINITIONS	166
PRINTER TABLES AND KV ROUTING	167
SYSTEM PRINTER CONFIGURATION	168
KITCHEN VIDEO ROUTING	169
KITCHEN PRINTER ROUTING.....	170
RECEIPT PRINTER ROUTING.....	171
DETAIL PRINTER ROUTING.....	172
INGREDIENT INVENTORY.....	173
INGREDIENT – DEFINITIONS	174
EDIT INGREDIENT	174
RECIPE TABLE	174
TIME ACTIVATED PROGRAM.....	175
TIME ACTIVATED – KEYBOARD LEVELS.....	176
KEYBOARD LEVEL.....	176
TIME ACTIVATED – PRICE LEVELS.....	177
PRICE LEVEL.....	177
TIME ACTIVATED – MACRO KEYS	178
MACROS	178
TIME ACTIVATED – STRING REPORTS	179
STRING REPORTS.....	179
TIME ACTIVATED – SHIFTS	180
SHIFT.....	180
TIME ACTIVATED – KITCHEN PRINTING.....	181
KP TIME PERIOD.....	181
PRODUCT MIX GROUPS PROGRAM.....	183

PRODUCT MIX GROUPS– DEFINITIONS.....	184
PRODUCT MIX GROUPS	184
PRODUCT MIX TIME PERIOD	184
MIX & MATCH TABLE PROGRAM	185
CUSTOM REPORT	186
CUSTOM REPORTS programming	186
CUSTOM REPORT - DEFINITIONS	187
CUSTOM REPORT – EDIT EXISTING REPORTS.....	188
EDIT EXISTING REPORTS	188
STRING REPORT.....	189
STRING REPORT - DEFINITIONS	190
PLU STOCK ENTRY	191
PLU STOCK ENTRY - DEFINITIONS	192
PLU STOCK MENU	192
PLU STOCK ENTRY	192
PLU MINIMUM STOCK PROGRAM	193
COPY PROGRAM	196
COPY PROGRAM - DEFINITIONS.....	197
COPY PLU.....	197
COPY KEYBOARD LEVEL.....	197
COPY WLU (Window Look UP)	197
PROGRAM FILE DOWNLOAD.....	198
PROGRAM FILE DOWNLOAD.....	199
P-MODE PROGRAM SCANS.....	200
NON PLU CODE PROGRAM.....	202
NON PLU – DEFINITIONS	203
PLU & WLU KEY RELOCATION.....	204
PLU KEYS.....	204
WLU KEYS (Window Look Ups).....	204
BITMAP FILE DOWNLOAD.....	205
X-MODE MANAGER MENU	207
Manager Operation	207
X-MODE REPORTS MENU.....	208
TRAINING.....	209
SET DATE & TIME	209
CASH DECLARATION	210
KEYBOARD & PRICE LEVEL	210
TIME CLOCK EDIT.....	211
X/Z1 (DAILY) TIME CLOCK EDIT	211
X/Z2 - X/Z5 TIME CLOCK EDIT	211
EDIT INVENTORY ITEM	212
EDIT PLU STOCK	213
STOCK MENU.....	213
DRAWER ASSIGNMENT PROGRAMMING	214
Z-MODE REPORTING	217
Z-REPORTS	217
REPORT LIST	219
FINANCIAL.....	221
SALES BY TIME PERIODS.....	223

PLU	223
PLU ZERO SALES	224
PLU SALES BY PRICE LEVEL	225
MIX AND MATCH	226
NOT FOUND PLU	226
EMPLOYEES	227
GROUPS BY EMPLOYEE	229
GROUP	230
DRAWER TOTALS	230
LABOUR GROUPS	232
SALES AND LABOUR %.....	232
DAILY SALES.....	233
GROUPS BY TIME PERIOD.....	233
ANALYSIS 1 BY TIME PERIODS	233
ANALYSIS 2 BY TIME PERIODS	234
ANALYSIS 3 BY TIME PERIODS	234
TRACK BY TIME PERIODS.....	234
OPEN CHECK.....	235
PRODUCT MIX.....	236
PRODUCT PROJECTIONS	236
STATION TOTALS.....	236
TIME KEEPING	237
DAY SHIFT.....	239
INVENTORY	242
INVENTORY DEFINITIONS	243
PLU STOCK.....	244
PLU STOCK BY GROUP	244
FOOD COST	244
PLU MINIMUM STOCK.....	246
ELECTRONIC JOURNAL.....	246
BITMAP FILE DOWNLOAD.....	248
PREPARE THE SPS1000 BITMAP DOWNLOAD.....	248
BIT MAP FILE SPECIFICATION	248
BITMAP FILE DOWNLOAD.....	249
DESIGN & SAVE A LOGO USING MICROSOFT PAINT.....	249
PC- SETUP OF A BITMAP	250
CONVERTING THE BITMAP FOR THE SPS1000	250
DOWNLOADING THE BITMAP TO THE SPS1000.....	250
DOWNLOADING THE BITMAP FILE TO THE PRINTER.....	250
PRINTING THE BITMAP IMAGE	250
PC- FLASH ROM DOWNLOAD.....	250
TO prepare receiving terminal	251
PC- FLASH ROM DOWNLOAD.....	252
<u>TO TRANSMIT FROM THE PC.....</u>	<u>252</u>
PC ROM ERASE	252
PC ROM DOWNLOAD	252
WIRING SPECIFICATIONS – SCANNERS.....	254
ZEEBEK SCANNER	254
SYMBOL SCANNER	254

WIRING SPECIFICATIONS – SCANNERS..... 255

 METROLOGIC MS700 Scanner..... 255

 METROLogIC MS951 Scanner..... 255

WIRING SPECIFICATIONS – PRINTERS 256

 PRINTER all samsung models 256

 RJ45- PRINTER all samsung models..... 256

WIRING SPECIFICATIONS – PC 257

 to P.C (Via Modem Connection) 257

 DIRECT CABLE TO PC..... 257

WIRING SPECIFICATIONS – PC RJ45 258

 (rj45) DIRECT CABLE TO PC 258

WIRING SPECIFICATIONS – IRC 259

 Two terminals..... 259

 To ETHERNET Hub..... 259

 LOOP BACK CONNECTOR 259

WIRING SPECIFICATIONS – PERIPHERALS 260

 SAMSUNG Pole Display 260

 Epson DP101 / DP102 Pole Display 260

WIRING SPECIFICATIONS – PERIPHERALS..... 261

 PORT LOCATIONS 261

 RS232,IRC and cash drawer PIN LOCATIONS 261



GETTING STARTED

REGISTER CONTROLS – DISPLAY

FRONT VIEW

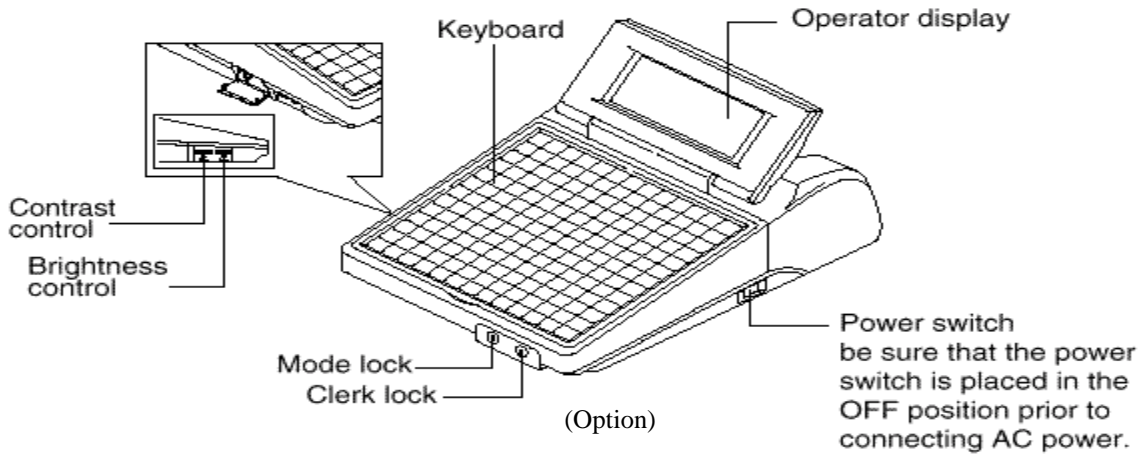

DISPLAY ADJUSTMENTS

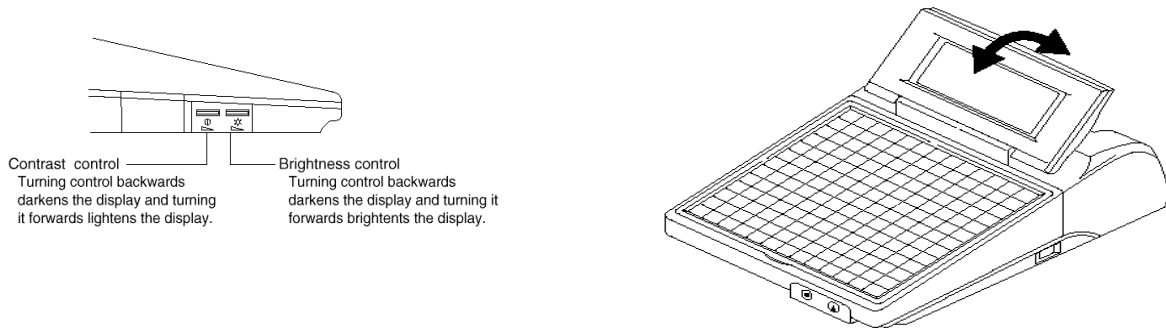

REAR VIEW

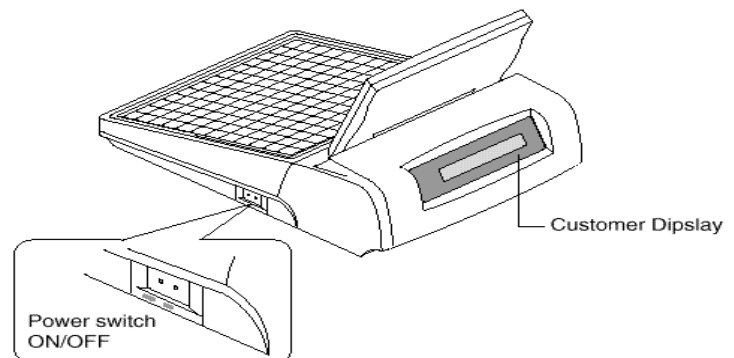

REGISTER CONTROLS – MODE LOCK

MODE LOCK

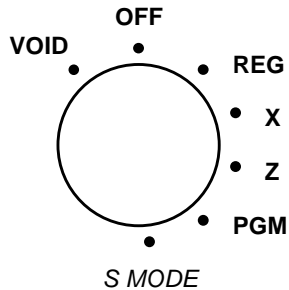

- VOID** Use to void (correct) items outside of a sale. Note the void mode can be deactivated using a system flag.
- OFF** The register is inoperable.
- REG** Use for normal registrations.
- X** Use to read register reports and perform other manager functions.
- Z** Use to read register reports and reset totals to zero.
- PGM** Use to program the register.
- S MODE** Use for tests and special settings. This position is not marked on the key lock.

The *SPS 1000* includes two sets of keys that can be used to access the following key lock positions.

KEY POSITIONS ACCESSIBLE

- REG** OFF, REG
- VD** VOID, OFF, REG, X
- Z** VOID, OFF, REG, X, Z
- P** VOID, OFF, REG, X, Z, PGM
- C** ALL POSITIONS

DEFAULT KEYBOARD

ESSENTIAL FUNCTION KEYS

The *SPS 1000* keyboard is programmable; you can design a keyboard that fits your exact needs.

The *Samsung SPS 1000* requires you to place the following keys on every keyboard

Numeric Keys **0-9**
CL/ESC
YES/NO
DONE

Cursor Control Keys **UP/DOWN/LEFT/RIGHT**
PAGE UP/PAGE DOWN
ENTER
X/TIME

The factory default keyboard is shown below.

13	26	39	52	65	78	91	104	CLERK 1	CLERK 2	CLERK 3	CLERK 4	CLERK 5
12	25	38	51	64	77	90	103	MENU LEVEL 1	MENU LEVEL 2	MENU LEVEL 3	MENU LEVEL 4	MENU LEVEL 5
11	24	27	50	63	76	89	102	PRICE LEVEL 1	PRICE LEVEL 2	PRICE LEVEL 3	PRICE LEVEL 4	PRICE LEVEL 5
10	23	26	49	62	75	88	101	REPEAT ORDER	PRINT BILL	OPEN BAR TAB	HOLD BAR TAB	LIST BAR TABS
9	22	25	48	61	74	87	100	GUEST NO.	TABLE NO.	OPEN CHECK NO.	HOLD CHECK	LIST CHECKS
8	21	24	47	60	73	86	99	PAID RECALL	YES/NO	ENTER	DONE	WLU NO.
7	20	33	46	59	72	85	98	EMPLO SIGN ON	PAGE UP	UP	PAGE DOWN	RCPT ISSUE
6	19	32	45	58	71	84	97	CLOCK IN/OUT	LEFT	DOWN	RIGHT	RCPT ON/OFF
5	18	31	44	57	70	83	96	TRANS CANCEL	CL/ESC	PLU NO.	X/TIME	MISC TEND 2
4	17	30	43	56	69	82	95	REFUND ITEM	7	8	9	MISC TEND 1
3	16	29	42	55	68	81	94	ERROR CORRCT	4	5	6	CHEQUE
2	15	28	41	54	67	80	93	RECVD MONIES	1	2	3	SUB-TOTL
1	14	27	40	53	66	79	92	PAID OUT MONIES	0	00	.	CASH

ALPHA OVERLAY KEYBOARD

ALPHA CHARACTERS

You have the option of using the Alpha Keyboard Overlay to enter descriptors (the default method) or you can enter descriptors by entering a three-digit character code for each character. (See System options-General Function Options in P-Mode Programming to select the method you want to program descriptors.)

The key layout of the Alpha Keyboard Overlay is shown below:

NOTE The DONE key acts as a backspace key when programming text.

!	@	#	\$	%	^	&	*	()	-	_	
Q	W	E	R	T	Y	U	I	O	P	+	=	\
A	S	D	F	G	H	J	K	L	:	;	"	'
Z	X	C	V	B	N	M	<	>	,	.	?	/
CAPS	SHIFT	BOLD	SPACE	SPACE	SPACE	SPACE	SPACE	●	{	}	[]
¼	½	¾	©	®	←	→	↑	↓		ENTER	BACK SPACE	F S
Ä	Å	Æ	Ö	Ü	Ñ	Ç			PAGE UP	UP	PAGE DOWN	T X
	ë	ï	ÿ	É	Ç				LEFT	DOWN	RIGHT	PREV REC
á	é	í	ó	ú					CL/ ESC		DELETE	NEXT REC
à	è	ì	ò	ù					7	8	9	
â	ê	î	ô	û					4	5	6	
ÿ á	ß	µ	Ø	EURO					1	2	3	
¢	£	¥	Pt	f					0	00	.	

ALPHA CODE PROGRAMMING

ALPHA CODES

You have the option of using the Alpha Keyboard Overlay to enter descriptors (the default method) or you can program descriptors by entering a three-digit character code for each character.

(See System Options-General Function Options in P-Mode Programming to select the method you want to program descriptors)

	CODE		CODE		CODE		CODE
A	065	a	097	0	048	<	060
B	066	b	098	1	049	=	061
C	067	c	099	2	050	>	061
D	068	d	100	3	051	?	063
E	069	e	101	4	052	@	064
F	070	f	102	5	053		
G	071	g	103	6	054	£	156
H	072	h	104	7	055	Pt	158
I	073	i	105	8	056	Fr	159
J	074	j	106	9	057		
K	075	k	107	!	033	½	171
L	076	l	108	”	034	¼	172
M	077	m	109	#	035		
N	078	n	110	\$	036		
O	079	o	111	%	037		
P	080	p	112	&	038		
Q	081	q	113	'	039		
R	082	r	114	(040		
S	083	s	115)	041		
T	084	t	116	*	042		
U	085	u	117	+	043		
V	086	v	118	,	044		
W	087	w	119	-	045		
X	088	x	120	.	046		
Y	089	y	121	/	047		
Z	090	z	122	:	058		
SPACE	032			;	059		

NOTE The DONE key acts as a backspace key when programming text.

DISPLAY OPERATION – CURSOR CONTROL

While you are programming the *SPS-1000*, the bottom line of the screen displays the keys that you are allowed to use next. (These prompts do not display while operating the *Samsung SPS 1000* in the REG key lock position, or in manager operations.)

For example, turn the key to the P position to view the P-MODE PROGRAMMING MENU:

CURSOR CONTROL

Function keys that you are allowed to use are displayed at the bottom of the screen.

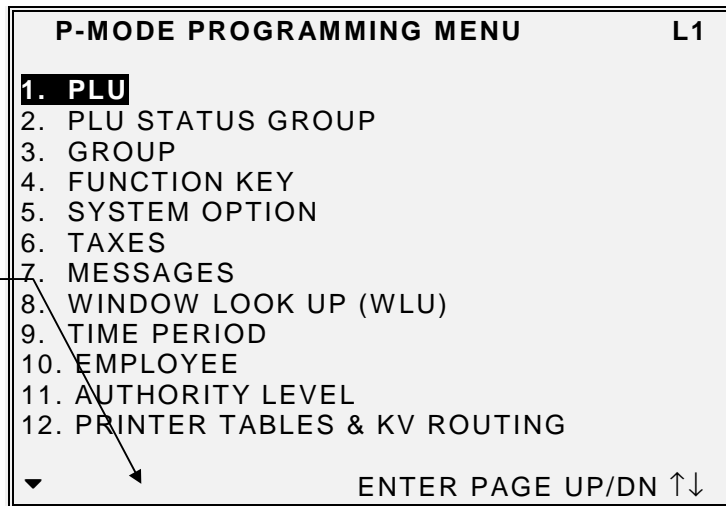

CHOOSING ITEMS FROM THE MENU

Choose an item from the menu in one of two ways:

- Type the number of your choice and press **ENTER**.
- Press the **UP** or **DOWN** keys to move the cursor to your choice and press **ENTER**.

The cursor automatically selects the first item when the menu screen is first opened.

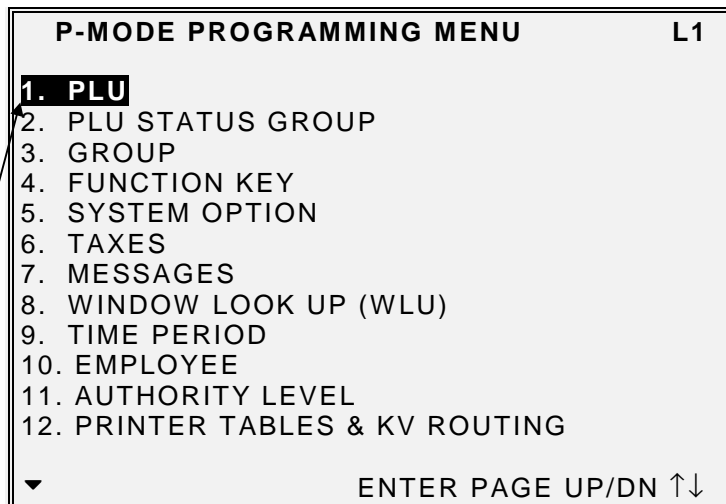

DISPLAY OPERATION – PAGE MOVEMENT

PAGE UP AND DOWN

The scroll indicators tell you if the area in which you are working (in this case General Printing Options Programming area) contains more information than can be displayed at one time.

Arrow down indicates more information below. Press **PAGE DOWN** to view the information below that currently displayed.

GENERAL PRINTING OPTIONS		L1
1. PRINT ON RECEIPT:		
EMPLOYEE NAME		Y
CONSECUTIVE #		Y
ITEMS BY GROUP		Y
DATE		Y
TIME		Y
PREAMBLE/POSTAMBLE		Y
ORDER #		Y
SEAT #		Y
2. RECEIPT FEED LINES AFTER PRINT	00	
3. LINES AFTER PREAMBLE	00	
4. LINES BEFORE POSTAMBLE	00	
5. BUFFERED RECEIPT: Y=STUB/N=FULL	N	
ESC Y/N ENTER PAGE UP/DN ↑↓←→		

Arrow up and down indicates more information above and below. Press **PAGE DOWN** to view the information below that currently displayed. Press **PAGE UP** to view the information above that currently displayed.

GENERAL PRINTING OPTIONS		L1
6. PRINT RECEIPT WHEN SIGNING ON/OFF		N
7. PRINT RECEIPT WHEN CLOCKING IN/OUT		N
8. CONDENSE TRAY SBTL RECEIPTS		N
9. JOURNAL: Y=REAL TIME/N=BATCH		N
10. PRINT PLU CODE WITH DESCRIPTOR		N
11. TRANSACTION # IS RANDOM NUMBER		N
12. HOME CURRENCY SYMBOL		£
13. CONVERTED CURRENCY 1 SYMBOL		€
14. CONVERTED CURRENCY 2 SYMBOL		@
15. CONVERTED CURRENCY 3 SYMBOL		@
16. CONVERTED CURRENCY 4 SYMBOL		@
17. CONVERTED CURRENCY 5 SYMBOL		@
18. PRINT TENDER ON RECEIPT		Y
ESC Y/N ENTER PAGE UP/DN ↑↓←→		

DISPLAY OPERATION – FIELD SELECTION

SELECTING FIELDS

- Press the **UP** or **DOWN** key to select the field above or below the current cursor position.
- With the field you wish to edit selected:
- For yes/no fields, press the **YES/NO** key to toggle from yes to no.
- For fields that accept numeric values, type the appropriate value using numeric keys. Values that are not allowed will not be accepted.

```

PLU#000000000000000001 PROGRAMMING L1
DESCRIPTOR :          PLU1
STOCK LINK PLU#          000000000000000000
MODIFIER QTY 0000    GROUP LINK # 1    01
PLU STATUS LINK#          01
PIECE COUNT   000    RECIPE#          01
ACTIVATE WLU#  00    MIX&MATCH TABLE# 01
INACTIVE      N    PRODUCT MIX#       01
PRESET?       Y    ALLOW PRICE CHANGE? N
ALLOW PRESET/HALO OVERRIDE?          N
PRICE/HALO    000000.00    PRICE LEVEL#1? 01
PRICE/HALO    000000.00    PRICE LEVEL#2? 02
PRICE/HALO    000000.00    PRICE LEVEL#3? 03
PRICE/HALO    000000.00    PRICE LEVEL#4? 04
PRICE/HALO    000000.00    PRICE LEVEL#5? 05
          PLU# ESC Y/N ENT PAGE UP/DN ↑↓←→
    
```

- Press **ENTER** to accept the new entry or press **DOWN** to accept the entry and advance to the next field

Press the **LEFT** or **RIGHT** key to select the field to the right or left of the current cursor position.

```

PLU#000000000000000001 PROGRAMMING L1
DESCRIPTOR :          PLU1
STOCK LINK PLU#          000000000000000000
MODIFIER QTY 0000    GROUP LINK # 1    01
PLU STATUS LINK#          01
PIECE COUNT   000    RECIPE#          01
ACTIVATE WLU#  00    MIX&MATCH TABLE# 01
INACTIVE      N    PRODUCT MIX#       01
PRESET?       Y    ALLOW PRICE CHANGE? N
ALLOW PRESET/HALO OVERRIDE?          N
PRICE/HALO    000000.00    PRICE LEVEL#1? 01
PRICE/HALO    000000.00    PRICE LEVEL#2? 02
PRICE/HALO    000000.00    PRICE LEVEL#3? 03
PRICE/HALO    000000.00    PRICE LEVEL#4? 04
PRICE/HALO    000000.00    PRICE LEVEL#5? 05
          PLU# ESC Y/N ENT PAGE UP/DN ↑↓←→
    
```

DISPLAY OPERATION – POP UP WINDOWS

OPENING POP-UP SELECTION WINDOWS

- The arrow indicates the selections for this field are made from a pop-up window.
- With the field selected and the cursor on the arrow, press **ENTER**. A pop-up window displays with the selections for the field listed.

GENERAL FUNCTION OPTIONS		L1
1. MANAGER CONTROL (IN X-MODE):		
NEGATIVE SALES		N
NEGATIVE TENDER		N
ZERO SALES		N
2. ENFORCE ANALYSIS1,2,3:		
AT BEGIN OF SALE		N
BEFORE TENDER		N
3. DEFAULT DESTINATION:	NONE	▾
4. ROUNDING ON % :	UP AT .5	▸
5. ROUNDING ON SPLIT PRICE/DECIMAL MULT	UP AT .5	▸
6. CONSOLIDATE LIKE ITEMS		Y
▼ ESC Y/N ENTER PAGE UP/DN ↑↓←→		

- Press the **UP** or **DOWN** keys to make your choice, then press **ENTER** to close the pop-up window. Your new choice is displayed.

GENERAL FUNCTION OPTIONS		L1
1. MANAGER CONTROL (IN X-MODE):		
NEGATIVE SALES		N
NEGATIVE TENDER		N
ZERO SALES		N
2. ENFORCE ANALYSIS1,2,3:		
AT BEGIN OF SALE		N
BEFORE TENDER		N
3. DEFAULT DESTINATION	NONE	▾
4. ROUNDING ON % :	5	▸
5. ROUNDING ON SPLIT PRICE/D	NONE	T
	ANALYSIS 1	5
	ANALYSIS 2	▸
	ANALYSIS 3	Y
6. CONSOLIDATE LIKE ITEMS		Y
▼ ESC Y/N ENTER PAGE UP/DN ↑↓←→		



DISPLAY MESSAGES

DISPLAY MESSAGES

AMOUNT REQUIRED

This operation requires an amount entry.

BAD VALUE

The number entered is incorrect for the task being performed.

BUFFER FULL

The buffer for soft check, hard check, or buffered receipt has reached capacity. For hard checks, the operator must press the SERVICE key to print the items and clear the buffer. The operator must then pick up the previous balance again in order to continue with finalisation. In a soft check environment, this message will appear when the check has reached capacity (maximum lines stored). The register will require the sale to be finalised with the option of printing a bill if required

BUFFER EMPTY

The buffer for WLU, REPEAT or PAID RECALL is empty.

BUSY

Destination register is busy (pre poll memory is in use). Requires a clear command from the P.C. or Register.

CASH DECLARATION REQUIRED

Cash declaration has been programmed as compulsory, and must first be performed before reports

CASH-IN-DRAWER EXCEEDED

The programmed Cash-In-Drawer limit has been exceeded.

CHECK# ASSIGNED AUTO

The operator has attempted to open a new guest check by assigning a check number. The register has been programmed to generate its own check numbers.

CHECK# REQUIRED !

This register has been programmed to force check number entry to begin a transaction. An existing guest check must be recalled, or a new one started.

CONDIMENT REQUIRED!

This PLU has been programmed to require a condiment entry.

CRC ERROR

An error has occurred in the block check sum while transferring data in IRC mode.

DISPLAY MESSAGES

ANALYSIS 1/2/3

This operation is set for compulsory entry of one of the three analysis keys.

ENTER EMPLOYEE CODE

The employee is required to sign on before performing a task.

ENTER EMPLOYEE #

The employee is required to sign on before performing a task.

ENTER GUEST COUNT

The operator must enter the number of guests when opening a guest check, or beginning a sale.

ENTER SEAT#

Seat # entry required before operation can continue.

ENTER TABLE#

Table number entry is required to open a guest check, or begin sale.

ENTRY REQUIRED

The function selected from the WLU requires a numeric entry, i.e. a percentage for an open percent discount.

ERROR

General error message.

ERROR JAM

Receipt / journal printer jammed message.

TABLE NUMBER IN USE

This check already exists.

HALO OVER

The amount entered exceeds the programmed HALO ie the task exceeds the maximum amount allowed.

ILLEGAL KEY SEQUENCE

The operator has used an illegal key sequence.

IN USE!

This guest check or clerk number is already open elsewhere in the system. This is also applicable when the floating clerk system is activated and the operator is in use on another terminal.

DISPLAY MESSAGES

INACTIVE!

The key pressed is inactive. This message also appears if VOID Mode has been disabled.

INPUT QTY

Quantity input is required for a condiment WLU

KITCHEN PRINTER FAILURE

The kitchen printer has failed to respond. Printing has been re-routed to the designated back-up printer is programmed.

MANAGER REQUIRED

This operation requires the key to be turned to the X position.

MANAGER OVERRIDE REQUIRE

The key lock should be moved to the X-Mode position in order to override a HALO amount, or other restriction.

MEMORY FULL

Memory is full.

NEGATIVE

This sale has gone negative. Negative sales are programmed as not allowed.

NO CHECK #

This message appears when the system cannot find this guest check number.

NO DATA

PLU can not be found (does not appear in Register Mode). Usually associated with stock entry on an IRC system when the PLU exists in one terminal but not another. On the terminal where the PLU does not exist the message not found will appear.

NO DRAWER!

The employee currently signed on is not assigned to a drawer, and is not allowed to perform cash sales, or the drawer is no longer attached and is required in order to continue.

NO MANUAL ENTRY

Manual entry is not allowed (scale function).

NO PAPER

Slip printer is out of paper, appears when printing to a loose-leaf printer.

DISPLAY MESSAGES

NO PLU!

The number entered is not a valid PLU. This message will also appear if a PLU number “built” using modifier keys recalls an invalid PLU number.

NON ADD# REQUIRED

This operation requires the entry of a Non-Add number to fulfill the compulsory requirements.

NOT DISCOUNTABLE

The preceding entry is not discountable, product is not available for discounting.

NOT PROGRAMMED!

This key has not been programmed

NOT READY!

Remote printer is not ready for printing tasks.

NOT ZERO

Displayed when trying to delete a PLU that still has sales counts and stock amounts. The PLU must first be reset and cleared from all Z Mode reports.

OFF LINE!

IRC communications have gone off line.

OPEN DRAWER

The register has been programmed not to operate with the cash drawer open.

P/BAL REQUIRED

This register has been programmed to require a previous balance entry.

PAPER END

The guest check printer has reached the end of the form, or the Receipt/Journal paper is at, or near, the end of its roll.

RANGE OVER

The number entered is out of range.

REMOVE PAPER

Validation is complete and the paper must now be removed.

DISPLAY MESSAGES

SCALE FAIL!

The register is not able to find the scale.

SCALE REQUIRED!

This item requires a weight this may be entered either manually or automatically.

SINGLE ITEM!

This PLU has been programmed as a single item PLU and cannot be used within a sale.

SUBTOTAL REQUIRED

The SUBTOTAL key must be depressed before continuing.

SYSTEM ERROR

Normal Operation error.

TARE# REQUIRED

This PLU/scale item requires a tare weight entry.

TRAY SUBTOTAL REQUIRED!

This prompt appears while in a TRAY SUBTOTAL transaction. The operator must first press the TRAY SUBTOTAL key before pressing any tender keys.

VALIDATION REQUIRED

This operation requires validation to complete the compulsory settings.

WASTE REQUIRED!

The operator is in the middle of a waste operation, and must depress the WASTE key in order to complete the operation.

WRONG EMPLOYEE

The employee attempting to open this guest check is not the original person who started the guest check. Also appears when attempting to sign on a new employee without first signing the current employee off, if overlap employee is not programmed.

SIGN OFF REQUIRED

This operation requires a SIGN-OFF.

ZERO AMOUNT

The register has been programmed to not allow negative sales, and to consider a zero amount as a negative sale.

DISPLAY MESSAGES

PRICE LEVEL MISMATCH

This PLU has no price that corresponds to the current price level.

OVERRIDE NOT ALLOWED

X-Mode override is not allowed for this operation.

WRONG SEQUENCE

The preceding key sequence is not allowed.

WRONG FILE NO

The file number do not match.

WRONG ITEMIZER

Wrong itemizer encountered.

UNDER TEND NOT ALLOWED

The under tendering is not allowed.

OVER TEND NOT ALLOWED

The over tendering is not allowed.

CHECK TRACKING ERROR

Error occurred during check tracking operation.

CHECK# IN USE

Current check number is already in use.

PLU NOT ALLOWED

PLU is not allowed in this operation.

CONDIMENT PLU NOT ALLOWED

Condiment PLU is not allowed in this operation.

NON-CONDIMENT PLU NOT ALLOWED

Non-Condiment PLU is not allowed in this operation.

FUNCTION KEY NOT ALLOWED

Function key is not allowed in this operation.

DISPLAY MESSAGES

THIS KEY NOT ALLOWED

This key is not allowed in this operation.

NO FUNCTION KEY

This key is not a function key.

NO PROGRAMMABLE KEY

This function key is not a programmable key.

X/TIME REQUIRED

This operation requires X/TIME.

INVALID AUTHORITY LEVEL

The authority level of the employee signed on does not allow this operation.

TIME IN REQUIRED

This operation requires TIME IN.

SIGN ON REQUIRED

This operation requires SIGN ON.

MEMORY NOT ALLOCATED

This report or programming file is not allocated in memory allocation.

THIS EMP. RPT MUST BE CLEARED

Issue the Z report of this employee in order to assign this employee to training employee file #.

ERROR STATUS

Current operation is not correct.

ERROR VALUE

The number entered is incorrect for the task being performed.

ERROR SYSTEM OPTION

System option error. Please check the appropriate system option in PGM or S mode.

ERROR EMPLOYEE

This employee is not acceptable.

DISPLAY MESSAGES

ERROR TABLE NO

Wrong table number entered.

SCALE MOTION

The scale is not settled down.

OVER WEIGHT

Weight is over the weighing capacity of scale.

UNDER WEIGHT

Weight is under the weighing capacity of scale.

PROMO NOT ALLOWED

This PLU does not allow promo operation. Please check the programming of PLU status group linked to this PLU.

WASTE NOT ALLOWED

This PLU does not allow waste operation. Please check the programming of PLU STATUS GROUP linked to this PLU.

NO FOOD STAMP AMOUNT

No food stamp eligible amount.

DECIMAL ENTRY NOT ALLOWED

The decimal entry is not allowed.

SPLIT PRICING NOT ALLOWED

The split pricing is not allowed.

VOID MODE IS DEACTIVATED

The transaction in VOID mode is deactivated. Please check the GENERAL FUNCTION OPTIONS.

JOB CODE REQUIRED

There is the part that do not include job code.

JOB CODE CHANGE NOT ALLOWED

JOB CODE change is not allowed. Please check the programming of AUTHORITY LEVEL linked to the employee.

DISPLAY MESSAGES

PUSH BUTTON ENTRY REQUIRED

Please use any of the 10 direct employee keys to sign on by direct key depression.

EMPLOYEE CODE NOT LINKED

The employee # is not linked this direct employee key. Please assign the employee # in GENERAL FUNCTION OPTIONS.

TENDERING IS NOT ALLOWED

This employee can do GUEST CHECK ENTRIES ONLY. Please check the programming of AUTHORITY LEVEL linked to the employee.

OVER REGULAR HOURS PER WEEK

The entered data exceeds the regular hours per week. Please check the TIME KEEPING OPTIONS programming.

MUST <= LINE# PER TRANSACTION

of lines per soft check should be less than or equal to # of lines per transaction.

MUST >= LINE# PER SOFT CHECK

of lines per transaction should be more than or equal to # of lines per soft check.

NO STOCK PLU

This PLU is not a STOCK PLU. Please check the programming of PLU status group linked to this PLU.

NEGATIVE CARD

Negative value not allowed.

LINKED STATUS REQUIRED

This PLU requires the linked PLU STATUS GROUP.

RETURN TO X-MODE

In order to exit the EDIT INVENTORY ITEM, the returning to X mode is required.

ERROR - SLIP PAPER

Error in printing on Slip printer.

LOCAL PRINTER REQUIRED

The local printer connected to this register is required.

DISPLAY MESSAGES

MODE ERROR

The mode should not be changed because the current task is not completed.

SET TIME&DATE IS DEACTIVATED

The setting time & date is deactivated. Please check the GENERAL FUNCTION OPTIONS programming.

EMPLOYEE SHOULD BE DIFFERENT

The TO EMPLOYEE should be different from the FROM EMPLOYEE in transfer check.

TRANSFER NOT ALLOWED

TRANSFER CHECK is not allowed. Please check the programming of AUTHORITY LEVEL linked to the employee.

REQ GALLONAGE AMOUNT

This entry involves a gallonage PLU, and requires an amount entry.

AVAILABLE ONLY IN CHECK

This operation is available only if check is opened.

SPLIT THIS ITEM NOT POSSIBLE

No more splitting this item is allowed.

FUNCTION KEY NOT INCLUDED

There is no function key in this WLU.

ERROR POST TENDER

Error in post tender operation.

NO TRACKING DATA IN THIS REG

There is no check tracking data in this register. Please check the S-MODE SYSTEM OPTIONS programming.

NO TIME KEEP DATA IN THIS REG

There is no time in/out data in this register. Please check the S-MODE SYSTEM OPTIONS programming.

MULTIPLICATION LIMIT EXCEEDED

The entered multiplier exceeds the direct multiplication maximum digit. Please check the GENERAL FUNCTION OPTIONS programming.

DISPLAY MESSAGES

TAB OF FIELD2 TOO BIG

TAB OR DECIMAL POINT OF FIELD 2 should be less than or equal to LENGTH OF FIELD 2.

NON-PLU CODE RANGE OVER

The digit of PLU code according to programming exceeds the digit of real PLU code.

TARE ENTRY NOT ALLOWED

Tare weight entry is not allowed. Please check the SCALE key programming.

MISC TEND REQUIRED

Any of the 16 MISC TEND keys is required for the task being performed.

NOT SCALEABLE PLU

This PLU is not a scaleable PLU. Please check the programming of PLU status group linked to this PLU.

EJ BUFFER FULL

Electronic Journal buffer is full.

MUST BE START<=END IN RANGE

START should be less than or equal to END in one range.

RANGE OVERLAP

START should be more than END of the preceding range.

FINAL END SHOULD BE 9 OR 99

END of the final range should be 9 or 99.

NOT PLU

The key that will be relocated should be PLU key.

NOT WLU

The key that will be relocated should be WLU key.

PRINT KEY REQUIRED

PRINT key is required for the task being performed.

SURCHARGE NOT ALLOWED

This PLU does not allow surcharge operation. Please check the programming of PLU STATUS GROUP linked to this PLU.

DISPLAY MESSAGES

DECIMAL ENTRY REQUIRED

The weight entry using DECIMAL key is required.

SYSTEM REG# REQUIRED

Please assign the appropriate register # to IRC FROM and IRC TO REGISTER # in S-MODE SYSTEM OPTIONS.

TRAINING EMP FILE# REQUIRED

Please assign the employee # to TRAINING EMPLOYEE FILE # in TRAINING MODE OPTIONS.

TIME IN/OUT REG# REQUIRED

Please assign the register # to REG# HOLDS TIME IN/OUT DATA in S-MODE SYSTEM OPTIONS.

CHECK TRACKING REG# REQUIRED

Please assign the register # to REG# HOLDS CHECK TRACKING DATA in S-MODE SYSTEM OPTIONS.

ELECTRONIC JOURNAL INACTIVE

ELECTRONIC JOURNAL is inactive. Please check the E.J. & DETAIL PRINTING OPTIONS programming.

CHEQUE ENDORSEMENT REQUIRED

CHEQUE ENDORSEMENT key is required for the task being performed.

EFT TERMINAL TRANS.KEY ERROR

The TRANSACTION KEY of EFT Terminal connected to entered key is incorrect. Please check the FUNCTION KEY programming.

CARD ERROR

General card error message.

PRINTER OFFLINE

Printer is off line.

KV OFFLINE

KV is off line.

NO RELOCATABLE KEY

This key is no relocatable key.

CLERK KEY ERROR

Wrong operation with real clerk key.

DISPLAY MESSAGES

ENFORCE ACTUAL INVENTORY

Please input ACTUAL INVENTORY at EDIT INVENTORY ITEM in X mode.

AUTHORITY LEVEL NOT LINKED

Authority Level should be linked to this employee.

WEIGHT IS ZERO

Weight on the scale is zero.

STOCK IS NOT ZERO

The STOCK of this PLU is not zero.

CLEAR CAN NOT BE REMOVED

If this position is relocated by other key except CLEAR key, CLEAR key will disappear on this keyboard.
Please leave one CLEAR key at least.

ENTER CAN NOT BE REMOVED

If this position is relocated by other key except ENTER key, ENTER key will disappear on this keyboard.
Please leave one ENTER key at least.

YES/NO CAN NOT BE REMOVED

If this position is relocated by other key except YES/NO key, YES/NO key will disappear on this keyboard.
Please leave one YES/NO key at least.

THIS NUMERIC CAN'T BE REMOVED

If this position is relocated by other key except this numeric key, this numeric key will disappear on this keyboard. Please leave one this numeric key at least.

INCORRECT CODE

There is no code that matched with the entered code.

SOFT CHECK ONLY

This operation can be done in only SOFT CHECK.

INACTIVE PLU

This PLU is inactive PLU.

MULTIPLE DISCOUNT NOT ALLOWED

Multiple Discount is not allowed.

DISPLAY MESSAGES

NEW CHECK OPENED

The requested check does not exist so a new check is opened.

NO MORE SPLIT TENDER ALLOWED

No more split tender is allowed.

CHECK POLE DISPLAY

Pole display is turned off or disconnected, check the pole display.

MUST MAX.NONTAXABLE<=BRK PNT1

MAXIMUM NON-TAXABLE AMOUNT should be less than or equal to BREAK POINT 1.

MUST BRK PNT N <= BRK PNT N+1

BREAK POINT should be less than or equal to the next BREAK POINT.

NOT ALLOWED WITH OPEN ORDERS

Z with open order is not allowed. Please check the REPORT OPTIONS programming.

NOW POLLING !!

Prepolling operation is in progress.

MIX AND MATCH ERROR

Wrong mix & match operation.

CLERK INTERRUPT ERROR

Clerk interrupt is not allowed or wrong operation was done.

CHECK OPENED NO DATA

NEW CHECK# key can not open a check.

NO CLERK BUFFER IN THIS REG

There is no clerk interrupt data in this register. Please check the S-MODE SYSTEM OPTIONS programming.

RESET PROCEDURES

ERROR CLEAR INIT PROCEDURE

The initial clear function allows you to exit any register activity and return to a beginning or cleared state. any transaction in progress will be exited and totals for that transaction are not updated.

Here are some reasons you may want to perform an initial clear:

- The register is in an unknown state, and you wish to exit the current program or transaction without following normal procedures.
- You have performed a function that includes a compulsory activity, such as validating or printing, and you wish to bypass the compulsory activity.
- An initial clear may be necessary as part of servicing, or troubleshooting an SPS 1000 register or system.

Contact your SAMSUNG dealer first if you have questions about operating or programming your SPS-1000.

TO PERFORM AN INIT CLEAR

1. Turn the power switch located on the right side of the register to the **OFF** position.
2. Turn the key lock to the **PGM** key lock position.
3. Press and hold the key position where the **CASH** key is located on the default keyboard layout.
4. Continue to hold the **CASH** key whilst turning the power switch to the **ON** position.
5. The P-MODE PROGRAMMING MENU will display when the initial clear is complete.

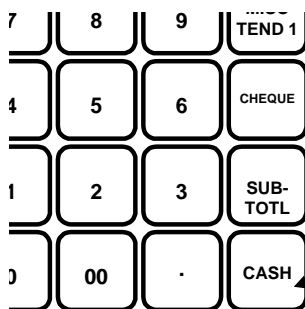

TO INITIALIZE:

Press and hold this key position during power-up in P-mode.

NOTE it may be required in some instances after a program init procedure to return to the REG position and press a tender key to complete the procedure

KEYBOARD CLEAR PROCEDURE

CAUTION: Distribute the S-Mode key only to those you may want to perform this function.

The keyboard clear function allows you to reset the custom keyboard back to factory settings

Here are some reasons you may want to perform an initial clear:

- Some or all of the essential Functions keys have been inadvertently programmed as other functions
- The custom-programmed keyboard is not required.

Contact your SAMSUNG dealer first if you have questions about operating or programming your SPS-1000.

TO PERFORM KEYBOARD CLEAR

1. Turn the power switch located on the right side of the register to the **OFF** position.
2. Turn the key lock to the **S-MODE** position (one position clockwise from the **PGM** key lock position).
3. Press and hold the key position where the **SUB-TOTL** key is located on the default keyboard layout.
4. Continuing to hold the **SUB-TOTL** key whilst turning the power switch to the **ON** position.
5. The S-MODE PROGRAMMING MENU will be displayed when this procedure has been completed.

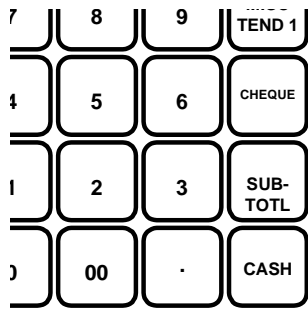

TO INITIALIZE:
Press and hold this key position
during power-up in S-MODE



S-MODE

CAUTION:

S-Mode functions are reserved for system providers who set-up and service your SPS1000 system.

The user will normally perform no S-Mode functions.

The procedures described in this area are security sensitive.

Many S-Mode functions, including memory clearing and memory allocation, will cause significant damage or loss to the user if they are performed without first backing up register data.

A special S-Mode key secures this mode, which is, located in an unmarked position one point clockwise from the PGM key lock position.

Distribute the special S-Mode key only to those you may want to perform these functions.

PROGRAM RESET

CAUTION: This will reset all programmed information, setting the machine back to factory default settings

This procedure will reset the machine back to factory settings, ready to commence program. There are two options for resetting; the first will load the default settings into the terminal, ready to commence programming. The second will prompt for user input of the file sizes. The first option is ideal for setting up demonstrations; the second is normally used for custom installations

TO A COMPLETE PROGRAM RESET

1. Turn the power switch located on the right side of the register to the **OFF** position.
2. Turn the key lock to the **S-MODE** position (one position clockwise from the **PGM** key lock position).
3. Press and hold the key position where the **CHEQUE** key is located on the default keyboard layout.
4. Continue to hold the **CHEQUE** key whilst turning the power switch to the **ON** position. (see figure 1)
5. Press each of the four corner keys
TOP LEFT, BOTTOM LEFT, TOP RIGHT, BOTTOM RIGHT (see figure 2)
6. You will be prompted as to whether you wish to load the default memory allocation, this is ideal for demonstrations as all defaults are set, and the terminal is immediately ready for feature programming. The alternative is to answer no and you will be prompted to enter your own file sizes, ideal for setting up custom installations. (see following for custom allocation definitions)

Figure 1.

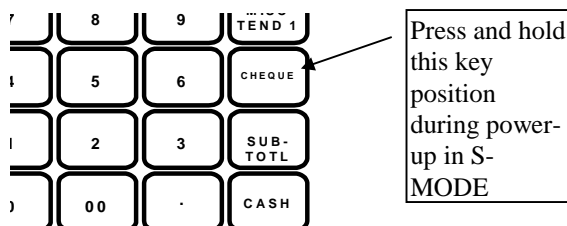
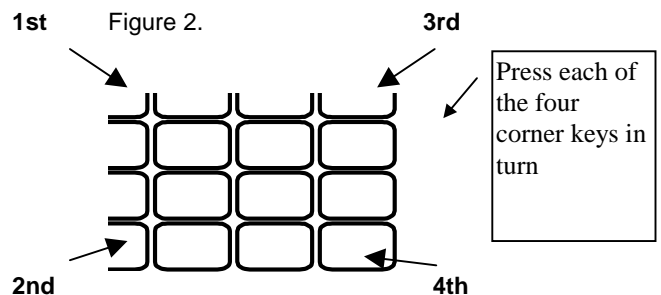

Figure 2.



MEMORY ALLOCATION

The Memory allocation is requested when the machine is program reset and default memory allocation is declined. The information can be displayed at any time by selection S-MODE option memory allocation.

The following entries define the file sizes for the terminal; once they have been entered they are fixed and can not be changed without program resetting the machine. All terminals within an IRC (inter register communications) system should ideally have identical memory allocations.

MEMORY ALLOCATION PROGRAMMING L1	
1. # OF DIGITS IN REPORT TOTALS (8-10)	08
2. # OF DIGITS IN REPORT COUNTERS(6-8)	6
3. # OF PLU	00220
4. # OF PLU STATUS GROUPS	0010
5. # OF PRICE LEVELS PER PLU (1-5)	4
6. PLU REPORT BY PRICE LEVEL	Y
7. # OF EMPLOYEE	005
8. # OF TIME ENTRIES PER EMPLOYEE	24
9. USE GROUP BY EMPLOYEE	N
10. CHECK TRACKING METHOD	SOFT
11. CHECK TRACKING FILES (0-4)	2
REMAINING MEMORY IS 6996 BYTES	
▼ ESC Y/N ENTER PAGE UP/DN ↑↓←→	

MEMORY ALLOCATION PROGRAMMING L1	
12. # OF LINES PER CHECK/INTERRUPT	030
13. # OF LINES PER TRANSACTION	050
14. MAXIMUM # OF CHECKS (ALL FILES)	00010
15. # OF TIME PERIOD (24/48/96)	24
16. # OF PRODUCT MIX GROUPS	005
17. # OF PROD MIX TIME PRDS (24/48/96)	24
18. PROJECTIONS	N
19. # OF WLU	010
20. # OF LINES PER WLU	10
21. # OF RECIPE	005
22. # OF INVENTORY INGREDIENT	015
REMAINING MEMORY IS 6996 BYTES	
◆ ESC Y/N ENTER PAGE UP/DN ↑↓←→	

MEMORY ALLOCATION PROGRAMMING L1	
23. # OF LINES FOR ELECT. JOURNAL	00000
24. # OF PAID RECALL TRANSACTIONS	03
25. # OF KEYSTROKES IN SUPER MACRO	0020
26. STORE BITMAP	N
27. ANALYSIS1 BY TIME PERIODS	Y
28. ANALYSIS2 BY TIME PERIODS	Y
29. ANALYSIS3 BY TIME PERIODS	Y
30. TRACK 1 BY TIME PERIODS	Y
31. TRACK 2 BY TIME PERIODS	Y
32. TRACK 3 BY TIME PERIODS	N
33. TRACK 4 BY TIME PERIODS	N
REMAINING MEMORY IS 6996 BYTES	
◆ ESC Y/N ENTER PAGE UP/DN ↑↓←→	

MEMORY ALLOCATION PROGRAMMING L1	
34. CLERK INTERRUPT	Y
35. # OF MIX & MATCH	05
36. REPORT SELECTION TABLE	
Y=YES, N=NO	Z1 Z2 Z3 Z4 Z5
FINANCIAL	Y Y N N N
EMPLOYEE	Y N N N N
PLU	Y N N N N
GROUP	Y N N N N
GROUP BY TIME PERIOD	Y N N N N
TIME PERIOD	Y N N N N
TIME KEEPING	Y N N N N
MIX & MATCH	Y N N N N
REMAINING MEMORY IS 6996 BYTES	
▲ ESC Y/N ENTER PAGE UP/DN ↑↓←→	

MEMORY ALLOCATION - DEFINITIONS

OF DIGITS IN REPORT TOTALS (8 - 10)

This is the length of the value field on read and reset reports

OF DIGITS IN REPORT COUNTERS (8 - 10)

This is the length of the quantity field on read and reset reports

OF PLU

This is the maximum number of PLUs (Price Look-Ups) you require in the system

OF PLU STATUS GROUPS

This is the maximum number of Status Groups. These are used to program common system flags to a group of PLUs and are required by the system.

OF PRICE LEVEL PER PLU (1 - 5)

This is the number of price levels per PLU. Each product has the ability to use five prices selected from twenty price bands. This allows the user to create a matrix of products, selected for sale using the correct price key. This also provides detailed report when used with the PLU report by price level.

PLU REPORT BY PRICE LEVEL

It is possible to produce a read and reset report listing the sales quantity and value for each of the five prices used per product, also providing an overall analysis of the sales quantities and values for the each price level.

OF EMPLOYEES

This is the number of operators for the system also including the total number of employees available for the time clock wage calculation feature. In order to produce the optional training financial report, include an additional employee.

OF TIME ENTRIES PER EMPLOYEE

This is the number of times an employee can clock into the system before a daily time keeping reset report is required to be printed. (I.e. the number of shifts per day)

USE GROUP BY EMPLOYEE

This used to provide additional labour and employee reporting analysis. I.e. the number of hours worked per job type

CHECK TRACKING METHOD (SOFT / HARD)

This is the method by which balances can be stored within the system. Soft refers to a complete detailed analysis with all product sales stored and printed. Hard refers to balance only storage.

MEMORY ALLOCATION - DEFINITIONS

OF TRACKING FILES (0 - 4)

The norm is to have one tracking file for table detail storage. This however can be increased to four, each running independently. This could be utilised to provide storage for Tables, Bar Check, Room Tabs, etc.

There is the additional option of providing a history for closed soft checks, Tracking file 2 will store closed checks for tracking file one and tracking file 4 will store 3, Normal tracking with not be done on files 3 and 4 whilst they are allocated to store history. The number of lines before wrap round begins is set in memory using # of lines per check.

OF LINES PER CHECK/INTERRUPT

This is the maximum number of product lines that can be stored per check, also when using clerk interrupt this is the number of lines that can be stored per clerk. This field also controls the number of history lines that can be stored for closed check tracking files before wrap round reporting begins.

OF LINES PER TRANSACTION

This is the maximum number of products, which can be sold per transaction and must be greater than the number of lines per check/interrupt.

MAXIMUM # OF CHECKS (ALL FILES)

This is the maximum number of checks that can be opened at once. The value you enter here provides that maximum for all of the check tracking files selected.

For example Entering 50 here will allow 50 checks for tracking file 1, and another 50 checks for tracking file 2 etc.

OF TIME PERIOD (24 / 48 / 96)

This is the number of time periods by which information will be analysed. This can be either 24-hourly, 48 - 1/2 hourly, 96 - 15 minutes. Further programming allows suppression and edit of any time report within the chosen range

OF PRODUCT MIX GROUPS

Product mix groups are used individual or for a group of products, providing an outer and single unit usage analysis The analysis is automatically updated when products are sold and no maintenance tasks are required by the user.

OF PROD.MIX TIME PRDS (24 / 48 / 96)

This is the number of time periods by which information will be analysed. This can be either 24-hourly, 48 - 1/2 hourly, 96 - 15 minutes. Further programming allows suppression and edit of any of the time periods within the chosen range.

PROJECTIONS

The product mix usage per time period can be used for defined weekly projections of product usage. This is in addition to the normal product usage, analysis report.

MEMORY ALLOCATION - DEFINITIONS

OF WLU (WINDOW LOOK UP UNITS)

This is the maximum number of window look-up menus available for PLU, Condiment and Function keys grouped together for display/selection.

OF LINES PER WLU (WINDOW LOOK UP UNITS)

This is the maximum number of items available for selection within one window.

OF RECIPE

Recipes can be used for stock control, When a product is sold; the information will be automatically calculated back through the recipe file in order to deduct the stock from the relevant ingredients. This is the maximum recipes available

OF INVENTORY INGREDIENT

This is the maximum number of ingredients required for recipe inventory stock control on the whole system.

OF LINES FOR ELECT. JOURNAL

This is the maximum number of lines available for the journal storage area before a reset report is required, one line is required for each line of normal print. Wrap round reporting can be activated with line by line override of the oldest data.

OF PAID RECALL TRANSACTIONS

It is possible to display the last transactions and issue copy receipts. This is the maximum number for recall.

OF KEYSTROKES IN SUPER MACRO

This is not related to the normal macro functions keys of which there are 40 with 50 keystrokes This is the number of keystrokes which can be stored in the terminals log file before wrap round reporting begins.

STORE BITMAP

This provides an area for receiving and printing a PC designed graphic logo. Bmp file

ANALYSIS1 BY TIME PERIODS

This allows analysis of a sale within a specific area, the sale total is stored under the analysis heading for reporting on the financial and appropriate time period report. The default text can be changed allowing monitoring of any area / category / department, The analysis keys can also be used to change the printer output for product orders.

MEMORY ALLOCATION - DEFINITIONS

ANALYSIS2 BY TIME PERIODS

This allows analysis of a sale within a specific area, the sale total is stored under the analysis heading for reporting on the financial and appropriate time period report. The default text can be changed allowing monitoring of any area / category / department, The analysis keys can also be used to change the printer output for product orders.

ANALYSIS3 BY TIME PERIODS

This allows analysis of a sale within a specific area, the sale total is stored under the analysis heading for reporting on the financial and appropriate time period report. The default text can be changed allowing monitoring of any area / category / department, The analysis keys can also be used to change the printer output for product orders.

TRACK 1 – 4 BY TIME PERIODS

This provides analysis of the closed/paid check tracking totals with the total monies received reported per hour.

CLERK INTERRUPT

This enables the layaway of active sales enabling more than one operator to use the terminal at a time

OF MIX & MATCH TABLE

These are the discount tables that are available for allocation to products for automatic sales discount .

REPORT SELECTION TABLE

This enables activation five reporting areas. Each of the five report areas can be read and reset independently.

SELF TESTS

The following procedures are used to perform diagnostic tests on the terminal. The integrity of peripherals are tested at this stage.

S-MODE PROGRAMMING MENU	L1
1. SELF TESTS	
2. MEMORY CLEAR	
3. MEMORY ALLOCATION DISPLAY	
4. KEYBOARD KEY RELOCATION	
5. SYSTEM OPTIONS	
6. PRINTER DRIVER SELECTIONS	
7. SERIAL PORT DEVICE SELECTIONS	
8. DEFINE SERIAL PORT PARAMETERS	
9. S-MODE PROGRAM SCAN PRINTING	
10. SYSTEM PASSWORD	
11. SUPER MACRO SCAN	
12. ROM FILE DOWNLOAD	
▼	ENTER PAGE UP/DN ↑↓

01	16:32:43	H/W TEST	1999.11.12 FRI
1. SERIAL & IRC LOOPBACK			
2. DRAWER			
3. RTC SETTING			
4. DISPLAY			
5. KEYBOARD			
6. MODE & CLERK KEY			
7. RAM			
8. IRC			
9. PRINTER			
10. RAM CHECKSUM			
11. VERSION CHECK			
ESC ENTER PAGE UP/DN ↑↓			

SELF TESTS - DEFINITIONS

SERIAL & IRC LOOP BACK

This is a diagnostics test for the serial port. Special Loop back connections are required.

DRAWER

This will test the opening of the cash drawers, there are 3 drawers available

RTC SETTING

This is the real time clock setting for the service mode.

DISPLAY

This will test the integrity of the display, and all display segments. The display can also be programmed with a screen saver so that the display switches to stand by after a number of minutes.

KEYBOARD

This will enable you to test any function key switch on the keyboard

MODE & CLERK KEY

This will test all mode lock positions and the clerk lock functions

RAM

This will test both reading and writing of the Random access memory

IRC

This will test the Ethernet inter register communication, helping to determine that all terminals are connected.

- Register # Setting** – This re-programs the terminal's register number
- Internal Loop Back(Chip)** – This tests the integrity of the internal loop back chip
- Internal Loop Back(Driver)** – This tests the terminals drivers
- External Loop Back** – This tests the loop back communications externally.
- IRC System Test** – This tests the Inter Register communications network and is useful

PRINTER

This will test any device connected to each of the seven output ports

RAM CHECKSUM

This will read and verify the Random access memory chips. (No data is affected when this procedure is run.)

VERSION CHECK

This will check and display the current operating version and available the number of products used out of the maximum number available, also showing the number of program initialisations performed also the number of power failures on the terminal.

MEMORY CLEAR

This provides a way of resetting a sales activity back to zero without carrying out reset reports, also the ability to reset site unique date such as PLUs etc..

NOTE Option 14 will reset/remove all programmed saleable items from the system completely and is not referring to PLU sales data.

S-MODE PROGRAMMING MENU	L1
<ol style="list-style-type: none">1. SELF TESTS2. MEMORY CLEAR3. MEMORY ALLOCATION DISPLAY4. KEYBOARD KEY RELOCATION5. SYSTEM OPTIONS6. PRINTER DRIVER SELECTIONS7. SERIAL PORT DEVICE SELECTIONS8. DEFINE SERIAL PORT PARAMETERS9. S-MODE PROGRAM SCAN PRINTING10. SYSTEM PASSWORD11. SUPER MACRO SCAN12. ROM FILE DOWNLOAD	
▼	ENTER PAGE UP/DN ↑↓

S-MODE MEMORY CLEAR	L1
<ol style="list-style-type: none">1. RESET ALL TTLS, CNTS & GRAND TTLS2. CLEAR TOTALS AND COUNTERS3. CLEAR GRAND TOTALS ONLY4. CLEAR ORDER TRACKING #15. CLEAR ORDER TRACKING #26. CLEAR ORDER TRACKING #37. CLEAR ORDER TRACKING #48. CLEAR PAID ORDER RECALL9. CLEAR PRODUCT PROJECTIONS10. CLEAR TIME-KEEPING11. CLEAR CLERK INTERRUPT12. CLEAR LOGO BITMAP IMAGE	
▼	ESC ENTER PAGE UP/DN ↑↓

S-MODE MEMORY CLEAR	L1
<ol style="list-style-type: none">8. CLEAR PAID ORDER RECALL9. CLEAR PRODUCT PROJECTIONS10. CLEAR TIME-KEEPING11. CLEAR CLERK INTERRUPT12. CLEAR LOGO BITMAP IMAGE13. CLEAR PRE-POLL STATUS FLAG14. CLEAR PLU FILE15. CLEAR SUPER MACRO16. CLEAR ELECTRONIC JOURNAL17. CLEAR INITIAL&POWER FAIL COUNTER18. CLEAR CONSECUTIVE#19. CLEAR ALL (1-11)	
▲	ESC ENTER PAGE UP/DN ↑↓

MEMORY CLEAR - DEFINITIONS

RESET ALL TTLS, CNTS & GRAND TTLS

This will remove any sales from the reporting memory, clearing all totals, including grand totals

CLEAR TOTALS AND COUNTERS

This will remove any sales from the terminals reporting memory, clearing all totals and counters. It will however leave the running grand totals in the system.

CLEAR ORDER TRACKING#1 - 4

This will clear the open check, setting the balance to zero. The sales are still retained for that check on the financial and product reports. This must be carried out on the terminal set by S-mode system options to store the check data.

CLEAR PAID ORDER RECALL

This is reset the memory for displaying paid transactions, the information will begin storing again

CLEAR PRODUCT PROJECTIONS

This will reset any information held in the product mix, sales projection files, which store the product usage, period projection analysis

CLEAR TIME-KEEPING

This will reset any employee time clock information, remove all hours worked totalisers and labour costing

CLEAR CLERK INTERRUPT

This will remove any sales currently open against an employee

CLEAR LOGO BITMAP IMAGE

This will remove from memory the computer download logo image file.

CLEAR PRE-POLL STATUS FLAG

If an unsuccessful attempt has been made to consolidate terminals sales data. The report is flagged as failed. This will remove that flag allowing normal reporting consolidation again.

CLEAR PLU FILE

This will completely remove the product file and any related data, ensure that any outstanding checks etc have also been cleared as they too will contain product data.

CLEAR SUPER MACRO

This will clear the terminals keystroke operation log file.

CLEAR ELECTRONIC JOURNAL

This will reset all sales data held within the electronic journal without printing. This can also be reset without printing in the Z mode position.

CLEAR INITIAL&POWER FAIL COUNTER

This will reset the counters on the self-test version check, which record the program initialisation and power failures

KEYBOARD KEY RELOCATION

Each one of the five keyboards can be programmed completely independently of the other.

Note: the following Essential Function Keys must be on each keyboard

Numeric Keys 0-9
CL/ESC
YES/NO
DONE

Cursor Control Keys UP/DOWN/LEFT/RIGHT
PAGE UP/PAGE DOWN
ENTER
X/TIME

S-MODE PROGRAMMING MENU **L1**

1. SELF TESTS
2. MEMORY CLEAR
3. MEMORY ALLOCATION DISPLAY
- 4. KEYBOARD KEY RELOCATION**
5. SYSTEM OPTIONS
6. PRINTER DRIVER SELECTIONS
7. SERIAL PORT DEVICE SELECTIONS
8. DEFINE SERIAL PORT PARAMETERS
9. S-MODE PROGRAM SCAN PRINTING
10. SYSTEM PASSWORD
11. SUPER MACRO SCAN
12. ROM FILE DOWNLOAD

▼ ENTER PAGE UP/DN ↑↓

KEYBOARD KEY RELOCATION **L1**

1. PLU KEYS
2. WLU KEYS
- 3. FUNCTION KEYS**

- 1. KEYBOARD LEVEL 1**
2. KEYBOARD LEVEL 2
3. KEYBOARD LEVEL 3
4. KEYBOARD LEVEL 4
5. KEYBOARD LEVEL 5

ESC ENTER PAGE UP/DN ↑↓

FUNCTION KEY RELOCATION PROGRAMMING **L1**
KEYBOARD LEVEL 1

- PRESS ANY KEY TO READ AND/OR CHANGE CURRENT ASSIGNMENT

OR

- PRESS ESC TO EXIT

FUNCTION KEY RELOCATION PROGRAMMING **L1**

KEYBOARD LEVEL : 1 KEY POSITION : 105
 CURRENT ASSIGNMENT : **013** ADD CHECK

1 NUMERIC 1	8 NUMERIC 8
2 NUMERIC 2	9 NUMERIC 9
3 NUMERIC 3	10 NUMERIC 0
4 NUMERIC 4	11 NUMERIC 00
5 NUMERIC 5	12 NUMERIC 000
6 NUMERIC 6	13 ADD CHECK
7 NUMERIC 7	14 BACK SPACE

▼

KEYBOARD KEY RELOCATION - DEFINITIONS

PLU KEYS

This allocates PLU product number keys to the keyboard. This will provided touch of the button entry for selling products. There are a maximum of five keyboards available each of which can have either the same product information or completely different product codes.

WLU KEYS (WINDOW LOOK UPS)

This allocates Window Look Up numbers to keys to the keyboard. This will provided touch of the button menu selection, These menu windows can contain products, function key list, or condiment instructions or a combination of any of those. Each of the five levels can have either the same product information completely different product codes, or even a mix of each.

FUNCTION KEYS

This is the main programming section as it determines the operation of each key

(Be aware of the required function keys shown at the beginning of this keyboard allocation section)

NOTE: If the keyboards are to be the same or similar it is possible to use the program mode 'Copy Program' Option this will save time by copying a programmed keyboard from one level to another.

FUNCTION KEY – LISTING

CODE	NAME	CODE	NAME	CODE	NAME
1	NUMERIC 1	70	MACRO PAUSE	139	MODIFIER4
2	NUMERIC 2	71	MACRO R (REG)	140	MODIFIER5
3	NUMERIC 3	72	MACRO S (S-MODE)	141	MODIFIER6
4	NUMERIC 4	73	MACRO SET (RECORD)	142	MODIFIER7
5	NUMERIC 5	74	MACRO VOID	143	MODIFIER8
6	NUMERIC 6	75	MACRO X	144	MODIFIER9
7	NUMERIC 7	76	MACRO Z	145	MODIFIER10
8	NUMERIC 8	77	MACRO1	146	NEXT RECORD
9	NUMERIC 9	78	MACRO2	147	#/NOSALE
10	NUMERIC 0	79	MACRO3	148	P/BAL
11	NUMERIC 00	80	MACRO4	149	PAGE DOWN
12	NUMERIC 000	81	MACRO5	150	PAGE UP
13	ADD CHECK	82	MACRO6	151	PAID OUT1
14	BACKSPACE	83	MACRO7	152	PAID OUT2
15	BOLD	84	MACRO8	153	PAID OUT3
16	CANCEL	85	MACRO9	154	PAID OUT4
17	CAPS	86	MACRO10	155	PAID OUT5
18	CASH	87	MACRO11	156	PAID RECALL
19	TIP DECLARE	88	MACRO12	157	% 1
20	SLIP	89	MACRO13	158	% 2
21	CHEQUE	90	MACRO14	159	% 3
22	CHEQUE CASH	91	MACRO15	160	% 4
23	CHK ENDORSE	92	MACRO16	161	% 5
24	CLEAR	93	MACRO17	162	% 6
25	CONTINUE	94	MACRO18	163	% 7
26	CURR CONV 1 EURO	95	MACRO19	164	% 8
27	CURR CONV 2	96	MACRO20	165	% 9
28	CURR CONV 3	97	MACRO21	166	% 10
29	CURR CONV 4	98	MACRO22	167	PLU
30	CURR CONV 5	99	MACRO23	168	PREV.RECORD
31	CUR DOWN	100	MACRO24	169	PRICE INQ
32	CUR LEFT	101	MACRO25	170	PRICE LVL1
33	CUR RIGHT	102	MACRO26	171	PRICE LVL2

FUNCTION KEY – LISTING

34	CUR UP	103	MACRO27	172	PRICE LVL3
35	DECIMAL	104	MACRO28	173	PRICE LVL4
36	DELETE	105	MACRO29	174	PRICE LVL5
37	DONE	106	MACRO30	175	PRICE LVL6
38	ANALYSIS3	107	MACRO31	176	PRICE LVL7
39	ANALYSIS1	108	MACRO32	177	PRICE LVL8
40	EMPLOYEE	109	MACRO33	178	PRICE LVL9
41	EMPLOYEE1	110	MACRO34	179	PRICE LVL10
42	EMPLOYEE2	111	MACRO35	180	PRICE LVL11
43	EMPLOYEE3	112	MACRO36	181	PRICE LVL12
44	EMPLOYEE4	113	MACRO37	182	PRICE LVL13
45	EMPLOYEE5	114	MACRO38	183	PRICE LVL14
46	EMPLOYEE6	115	MACRO39	184	PRICE LVL15
47	EMPLOYEE7	116	MACRO40	185	PRICE LVL16
48	EMPLOYEE8	117	MACRO # (CODE NO.)	186	PRICE LVL17
49	EMPLOYEE9	118	MDSE RETURN	187	PRICE LVL18
50	EMPLOYEE10	119	MISC TEND1	188	PRICE LVL19
51	ENTER	120	MISC TEND2	189	PRICE LVL20
52	ERR.CORR.	121	MISC TEND3	190	PRINT
53	FD/S SHIFT	122	MISC TEND4	191	PRINT CHECK
54	FD/S SUBTL	123	MISC TEND5	192	PRINT HOLD
55	FD/S TEND	124	MISC TEND6	193	PROMO
56	GUEST #	125	MISC TEND7	194	PRT SCREEN
57	HOLD	126	MISC TEND8	195	QUIT
58	INACTIVE	127	MISC TEND9	196	RCPT ON/OFF
59	KEYBD LVL1	128	MISC TEND10	197	RECALL CHK1
60	KEYBD LVL2	129	MISC TEND11	198	RECALL CHK2
61	KEYBD LVL3	130	MISC TEND12	199	RECALL CHK3
62	KEYBD LVL4	131	MISC TEND13	200	RECALL CHK4
63	KEYBD LVL5	132	MISC TEND14	201	RECD ACCT1
64	LIST CHECK1	133	MISC TEND15	202	RECD ACCT2
65	LIST CHECK2	134	MISC TEND16	203	RECD ACCT3
66	LIST CHECK3	135	MISC TEND#	204	RECD ACCT4
67	LIST CHECK4	136	MODIFIER1	205	RECD ACCT5

FUNCTION KEY – LISTING

68	MACRO OFF	137	MODIFIER2	206	RECEIPT
69	MACRO P	138	MODIFIER3	207	REPEAT
208	SCALE	231	TIME IN/OUT (CLOCK IN/OUT)	254	NOFOUND PLU
209	SEAT #	232	TIP1	255	PRICE CHG
210	SHIFT	233	TIP2		
211	SPLIT ITEM	234	TIP3		
212	SPLIT PAY	235	TRANS CHK1		
213	STOCK INQ	236	TRANS CHK2		
214	STORE CHK1	237	TRANS CHK3		
215	STORE CHK2	238	TRANS CHK4		
216	STORE CHK3	239	TRAY SUBTL (TICKET ISSUE)		
217	STORE CHK4	240	VALID		
218	SUBTOTAL	241	VOID ITEM		
219	TABLE 1	242	WASTE		
220	TABLE 2	243	WLU		
221	TABLE 3	244	X/TIME		
222	TABLE 4	245	YES/NO		
223	ANALYSIS2	246	PARK ORDER		
224	TAX EXEMPT	247	SERVE ORDER		
225	TAX SHIFT1	248	KP ROUTING		
226	TAX SHIFT2	249	SPLIT CHECK		
227	TAX SHIFT3	250	NEW CHECK1		
228	TAX SHIFT4	251	NEW CHECK2		
229	TAX SHIFT5	252	NEW CHECK3		
230	TAX SHIFT6	253	NEW CHECK4		

FUNCTION KEY - DEFINITIONS

NUMERIC 1

Used to reposition the numeric keypad anywhere on the keyboard

NUMERIC 2

Used to reposition the numeric keypad anywhere on the keyboard

NUMERIC 3

Used to reposition the numeric keypad anywhere on the keyboard

NUMERIC 4

Used to reposition the numeric keypad anywhere on the keyboard

NUMERIC 5

Used to reposition the numeric keypad anywhere on the keyboard

NUMERIC 6

Used to reposition the numeric keypad anywhere on the keyboard

NUMERIC 7

Used to reposition the numeric keypad anywhere on the keyboard

NUMERIC 8

Used to reposition the numeric keypad anywhere on the keyboard

NUMERIC 9

Used to reposition the numeric keypad anywhere on the keyboard

NUMERIC 00

Used to reposition the numeric keypad anywhere on the keyboard

NUMERIC 000

Used to reposition the numeric keypad anywhere on the keyboard

ADD CHECK

Used to add multiple guest checks (soft checks) for payment together or to add check between different tracking files. or to move one check to another.

BACK SPACE

Used to program the alpha programming BACKSPACE function key

FUNCTION KEY - DEFINITIONS

BOLD

Used to program the alpha programming BOLD function key

CANCEL

Press the cancel to abort a transaction in progress. All current items are removed (voided)

CAPS

Used to reposition the alpha programming CAPTIAL Letters lock function key

CASH

Used to finalise or tender cash sales. Change is computed when the amount of the cash tender is greater than the amount of the sale. There is also the programmable option of allowing change to be calculated once a sale has been completed using the post tender system flag.

TIP DECLARE

This is used for the declaration of tips earned by employees

SLIP

Used to print guest check bills to a loose-leaf paper printer

CHEQUE

Use the cheque key to finalise or tender cheque sales. Change is computed when the amount of the cheque tender is greater than the amount of the sale. This can be used as a cash back feature for cheque payments.

CHEQUE CASH

Use the Check Cashing key to exchange a cheque for cash outside of a sale.

CHECK ENDORSEMENT

This will print onto the check an endorsement message (only on printer models with a validation sensor)

CLEAR

Press CLEAR to clear numeric entries or error conditions

CONTINUE

Used in-conjunction with the magnetic card swipe system

CURR CONV 1 - 5

Used to convert and display the value of the transaction in foreign currency. This works also for Euro dual pricing in-conjunction with system printing flags. It is assumed currency rate one is the Euro exchange rate

FUNCTION KEY - DEFINITIONS

CURSOR DOWN

Use the cursor control keys to relocate the position of the cursor on the screen

CURSOR LEFT

Use the cursor control keys to relocate the position of the cursor on the screen

CURSOR RIGHT

Use the cursor control keys to relocate the position of the cursor on the screen

CURSOR UP

Use the cursor control keys to relocate the position of the cursor on the screen

DECIMAL

Use the decimal key to enter fractional rates or percentages. Do not use to enter amounts. The decimal is automatically inserted in the correct position.

DELETE

Used to program the alpha programming DELETE function key.

DONE

Press DONE to exit a WLU screen when multiple entries are allowed on the WLU. This key is required for programming and should not be omitted from the keyboard. This key also acts as a backspace when programming alpha.

ANALYSIS 3

This key is used to record sales totals providing analysis on the both the financial report and special hourly sales analysis report. The default text can be changed providing sales analysis for any category. This key can also be programmed to switch the printing area of kitchen orders.

ANALYSIS 1

This key is used to record sales totals providing analysis on the both the financial report and special hourly sales analysis report. The default text can be changed providing sales analysis for any category. This key can also be programmed to switch the printing area of kitchen orders.

EMPLOYEE # (CASHIER)

The employee number key is used to sign on the cashier, clerk, server or employee who is starting registration. This key is used for CLERK CODE entry.

EMPLOYEE 1- 10

The employee keys 1 – 10 can be programmed to sign on a specific cashier when pressed directly without entering a code. These keys are used for PUSH Button clerk entry

FUNCTION KEY - DEFINITIONS

ENTER

When programming press the ENTER key to place data into a field with the cursor remaining in the field.

ERR CORRECT

Press the error correct key to remove an item from the sale total. This also acts as delete when programming WLUs

FD STAMP SHIFT

Press FD STAMP SHIFT to shift the pre-programmed food stamp voucher status of an item prior to its registration.

FD STAMP SUBTTL

Press FD STMP SUBTTL to display the total of food stamp voucher eligible items registered in the current transaction.

FD STAMP TENDER

Use the FD STMP TENDER key to tender Food Stamp vouchers after the display of the food stamp eligible subtotal. Depending upon function key programming, change less than £1 can be applied to any cash balance or issued as cash change.

GUEST #

Used to record the number of guests served by a transaction. The entry may be compulsory, the entry can also be programmed to appear on printers

HOLD

Used to identify an individual item, or an entire transaction, in order that the selected items will not print/display on the kitchen printer / KVS when the transaction is finalised. The system can be programmed to warn if items are held when a check is stored, also to automatic select ready for print when a check is recalled.

INACTIVE

The inactive function key can be re-used as many times as necessary to inactivate key locations

KEYBOARD LEVEL 1 - 5

Use to select one of the five keyboard levels. Keyboard levels can be changed manually using these keys or automated to change at a pre-programmed time on a pre-programmed day. They can also be changed in X-mode.

LIST CHECK 1 - 4

Press the List Check key to display a list of open checks.

FUNCTION KEY - DEFINITIONS

MACRO OFF

This switches the macro during the pre-programmed key sequence to the Off position. This key is not required on the keyboard as it is accessed during macro programming

MACRO P

This switches the macro during the pre-programmed key sequence to the P-MODE position. This key is not required on the keyboard as it is accessed during macro programming

MACRO PAUSE

Used to indicate a pause in the macro, allowing greater user choice for the display and operation of macros one pause is programmed per required key press.

MACRO R

This switches the macro during the pre-programmed key sequence to the Register mode position. This key is not required on the keyboard as it is accessed during macro programming

MACRO S

This switches the macro during the pre-programmed key sequence to the S-mode position. This key is not required on the keyboard as it is accessed during macro programming

MACRO SET

This key is used in REG as a method of programming macros by recording the key-strokes as they are entered. By pressing the MACRO SET key carrying out the require mode changes, key-strokes etc then pressing the MACRO1-40 key to finalise the sequences to that key.

MACRO VOID

This switches the macro during the pre-programmed key sequence to the Void-mode position. This key is not required on the keyboard as it is accessed during macro programming

MACRO X

This switches the macro during the pre-programmed key sequence to the X-mode position. This key is not required on the keyboard as it is accessed during macro programming

MACRO Z

This switches the macro during the pre-programmed key sequence to the Z-mode position. This key is not required on the keyboard as it is accessed during macro programming

MACRO 1 - 40

Used to execute one of the forty possible pre-programmed key sequences, by allocating the required key and then programming the appropriate sequence. Macros can be included in a Window

MACRO #

Used to execute one of forty possible macros by entering the macro number and pressing the macro code entry key

FUNCTION KEY - DEFINITIONS

MDSE RETURN

Used to remove items from the sales totals and return goods back into stock. This key can be used within or outside of a transaction

MISC TEND 1 - 16

Use a MISC TEND key to finalise or tender sales paid by various charges or other media. Tendering may or may not be allowed depending upon programming

MISC TEND #

Used to access by code any one of the 16 MISC TEND keys used to finalise or tender sales paid by various charges or other media. Tendering may or may not be allowed depending upon programming

MODIFIER 1 - 10

Preceding a PLU entry a modifier key changes one digit of the PLU number, causing a different PLU to be registered. MODIFIER Keys can be set to change either the item code or the description only. This can be used to build up a code number system with various modifiers working together to sell a compiled code. For example if MODIFIER 1 is set to change the 4th digit of the PLU by 4 and MODIFIER 2 is set to change the 3rd digit by 5 pressing MODIFIER 1 then MODIFIER 2 followed by PLU 1 would sell code 4501 PLU 2 would become 4502 etc..

NEXT RECORD

Used to program the next record key, which is used during programming to move through the program records.

#/NOSALE

Used to enter a non-adding memo number during a transaction (# function) or used to open the cash drawer outside of a sale

P/BAL

Enter an amount, then press the manual previous balance (P/bal) key to use the simplest form of Charge Posting / Table Service.

PAGE DOWN

This key switches between pages on the register display. Used in Window Look-Ups etc.

PAGE UP

This key switches between pages on the register display. Used in Window Look-Ups etc.

PAID OUT 1 - 5

Press a Paid Out key to register monies removed from the cash drawer

FUNCTION KEY - DEFINITIONS

PAID RECALL

The paid recall key is used to recall the last xx number of transactions, where xx is defined in the memory. Pressing RECEIPT ISSUE key whilst a transaction is displayed will result in a copy receipt for the sale, being printed.

%1 - %10

Ten discount/Premium keys are available to handle various types of discounts, mark downs and adjustments to items or transactions.

PLU

Used to register a PLU by entering the appropriate PLU number and pressing the PLU/# key

PREVIOUS RECORD

This key is used to switch to the previous PLU entered.

PRICE INQUIRY

Used to inquire on the retail price of a product this can be programmed to display for a single item or multiple products

PRICE LEVEL 1 - 20

Press a price level key prior to a PLU entry to shift the price of a PLU to a different '*price set*' pre-programmed to the PLU. Each product has the ability to sell at five different prices. The prices are not fixed however at price levels 1 through to five. The Price level can be allocated from any of the twenty to provide detailed price reporting using the PLU by price level report (if set in memory allocation). The norm for a bar is two prices normal and special offer price this requires no special programming. The terminal however can be programmed to used up to twenty price bands. For example we could have some PLUs using prices 1 – 5 representing sizes and some PLUs using prices 6 – 10. This would then representing different products types sold at different sizes; pressing the appropriate price key will sell the correct size. Then using the price level report, the analysis would show the total per product a breakdown of the price sales per product and overall sales total for all products per price level

PRINT

This key is used to temporarily change the remote printer settings of a PLU allowing printing to the programmed printer route allocated to this key. It is required that a product to print has KP Print set to Y to allow the item to be printed.

PRINT CHECK

Used during any open check or after finalisation to print a detailed bill for check tracking files 1 – 4, The bill can if required be programmed to print automatically to the printer defined by this key.

PRINT HOLD

Used to remove the HOLD designation from an item or order, so that the items and their instructions are now sent to the kitchen printer/KVS at finalisation

FUNCTION KEY - DEFINITIONS

PROMO

Press the PROMO key to void the price (the item remains). This can be used in 2 for 1 promotions etc. A promo count and value of discount given is shown on the financial reports.

PRINT SCREEN

Press the print screen key to print a copy of the current screen on the designated receipt printer

QUIT

Press QUIT to automatically sign on/off the current cashier/clerk, when using the magnetic card swipe.

RECEIPT ON /OFF

This is used to turn the receipt off, The receipt can be programmed using system flags to be a continuous receipt with the ability to issue a post receipt (default setting) or to print only when the post receipt key is pressed.

RECALL CHECK 1 - 4

The Check Tracking System can Maintain only balances (hard checks) or entire transactions (soft checks) in the register memory. Four different tracking files can be separated to maintain different information eg bar tabs, tables etc. The check number can be entered by the employee or be programmed to be an automatically generate a number.

RECD ACCT 1 - 5

Press a RECD ACCT key to register monies added to cash, check or miscellaneous media to the drawer

RECEIPT ISSUE

Press this key to issue a copy receipt. This key can also be used with PAID RECALL to issue receipts of past sales.

REPEAT

Use the repeat key to quickly re-order a set of items, for a check tracking sale. This key repeats the last check order which has previously been stored.

SCALE

Use the scale key to automatically display the weight from a scale connected to the register, or to manually enter a weight for extension.

FUNCTION KEY - DEFINITIONS

SEAT#

Used to identify a specific seat (or person) within a transaction. Facilitates separate payment by seat from a single check and identifies to the food preparation staff how to assemble meals. This feature also provides separate billing

To allocate items to a seat enter the seat number and press the seat key prior to selling the product or scroll through the items on the display and allocate by pressing the seat key followed by the seat number then the seat key again to accept. Payment is accepted by pressing subtotal then the seat key to display and pay the balances due.

SHIFT

Used to program the alpha programming Shift capital letters lock function key

SPLIT ITEM

When like items are consolidated in a transaction. You can move the cursor to the item and press the SPLIT ITEM key to display the items separately, instead of in consolidated form, used normally to assist the items to seat allocation.

SPLIT PAYMENT

Use the split payment key to divide the amount of a guest check into equal segments for payment and issue bills accordingly. To pay bills using the split payment method, recall the guest check press the subtotal key then enter the number of people by which the bill is to be split then press the split payment key to activate the display of balances due for payment for each person.

STOCK INQUIRY

Used to display the current stock situation for a PLU, this will display the total stock for all the registers in the system. This can be programmed to display stock for one item then return to register mode or display stock for each product pressed until clear is used to exit.

STORE CHECK 1 - 4

The check tracking system can maintain only balances (hard check) or entire transactions (soft check) in the register memory. Four different tracking files can be separately maintained. The system can allow the operator to enter the check number manually using the RECALL CHECK key or to automatically generate a check number.

SUBTOTAL

Used to display the balance due. This can be programmed to print on request

TABLE 1 - 4

This is used for reference as to which table a check is related to, there can be numerous checks per table, depending upon, programming of the store check key. There is also the feature that checks can be recalled using the table number, if the table applies to more than one check all relevant checks will be displayed in a selection window.

FUNCTION KEY - DEFINITIONS

ANLAYSIS 2

This key is used to record sales totals providing analysis on the both the financial report and special hourly sales, analysis reports. The default text can be changed providing sales analysis for any category. This key can also be used to change the print location of a kitchen order.

TAX EXEMPT

The Tax Exempt can be programmed to exempt specific taxes from a sale.

TAX SHIFT 1 - 6

These are used to change temporarily the pre-programmed tax rate of a product.

TIME IN/OUT (CLOCK IN/OUT)

Enter the employee clock in code then press the key to record start and end work times, breaks etc. Hours are maintained by the time clock system. There are various analysis reports for labour costing analysis to assist with management of this feature.

TIP 1 - 3

Used to enter a tip amount on a check tracking bill, the tip keys can be programed as either and percent or amount.

TRANSFER CHECK 1 - 4

Used to transfer check monies/open checks from one employee to another. This key is not used for check numbers.

TRAY SUBTOTAL (TICKET ISSUE)

This key provides excellent flexibility of receipt issuance. The sale is entered as normal in register when a receipt is required this key is pressed and a receipt for all items sold to that point is issued.

VALIDATE

Use this key to initiate a single line validation (a printer with validation capability must be connected)

VOID ITEM

This key is used to remove an item from a transaction. Locate the cursor on the item press the VOID key.

WASTE

This is used to start and end entries of items that are wasted. A waste count is maintained for each item and the inventory is adjusted, counters and values are provided on the financial reports.

WLU #

Used to access windows look up menus by their code number or to allocated a WLU one touch button to the keyboard

FUNCTION KEY - DEFINITIONS

X/TIME

Used for multiplication and split pricing entries in the register position.

PARK ORDER/SERVE ORDER

Used with the kitchen video system to control order service

KP ROUTING

The system stores four periods of order printing sequences for example during the day the bar printer may print both food and drinks items whilst in the evening the bar prints drinks only and the restaurant printer issues food orders. This can be changed automatically using time periods or manually using this key.

NEW CHECK 1 – 4

The standard recall check key allows a check to be opened if it does not already exist. This is excellent in hospitality tracking, however for account management credit may not so readily be given. Therefore when this button is programmed accounts are not opened automatically. A warning will indicate an account does not exist if an attempt is made to open using the recall check key. The new check button is used to open new accounts. The programmability for this key is automatically picked up from the status of the Recall check key.

NOFOUND PLU (NOT FOUND PLU)

If a code is entered or scanned that does not exist It is then possible using this key to create that item.

PRICE CHANGE

This allows the pre-programmed price of an item to be changed. There are optionally programmed restrictions

S-MODE SYSTEM OPTIONS

This section is used to define the most fundamental parameters of the whole system such as, how many machines are in the network, which machine number will store common data etc.

S-MODE PROGRAMMING MENU	L1
1. SELF TESTS	
2. MEMORY CLEAR	
3. MEMORY ALLOCATION DISPLAY	
4. KEYBOARD KEY RELOCATION	
5. SYSTEM OPTIONS	
6. PRINTER DRIVER SELECTIONS	
7. SERIAL PORT DEVICE SELECTIONS	
8. DEFINE SERIAL PORT PARAMETERS	
9. S-MODE PROGRAM SCAN PRINTING	
10. SYSTEM PASSWORD	
11. SUPER MACRO SCAN	
12. ROM FILE DOWNLOAD	
▼	ENTER PAGE UP/DN ↑↓

S-MODE SYSTEM OPTIONS	L1
1. REGISTER # (01 – 32)	01
2. STORE #	000000
3. IRC : FROM REGISTER #	01
4. IRC : TO REGISTER #	01
5. IRC # OF RETRIES	00
6. PRINT/DISPLAY DECIMAL POSITION	2•
7. SEND PLU DESCRIPTOR WHEN POLLED	Y
8. PASSWORD (0000=NO PASSWRD): X =0000	
	Z1=0000
	Z2=0000
	Z3=0000
	Z4=0000
	Z5=0000
▼	ESC Y/N ENTER PAGE UP/DN ↑↓

S-MODE SYSTEM OPTIONS	L1
9. REG HOLDS TIME IN/OUT DATA	01
10. REG# HOLDS CHECK TRACKING DATA	
CHECK#1	01
CHECK#2	01
CHECK#3	01
CHECK#4	01
11. REG# HOLDS BACKUP CHECK TRACK DATA	
CHECK#1	02
CHECK#2	02
CHECK#3	02
CHECK#4	02
12. REG# HOLDS KP GLOBAL ORDER#	01
13. REG# HOLDS CLERK INTERRUPT DATA	01
◆	ESC Y/N ENTER PAGE UP/DN ↑↓

S-MODE SYSTEM OPTIONS	L1
14. ROM FILE DOWNLOAD PASSWORD	9999
(0000=NO PASSWORD)	
▲	ESC Y/N ENTER PAGE UP/DN ↑↓

S-MODE SYSTEM OPTIONS – DEFINITIONS

REGISTER # (1-32)

This is the register number for this terminal. This is required to be a sequential number starting from 1 (the master) then in turn for each of the terminals in an inter-register communications system.

STORE #

This is used during communications to indicate which store sales are collected from. Defaults to 0s

IRC : FROM REGISTER

This is the number of the first terminal in an inter-register communications system. The norm is 1

IRC : TO REGISTER

This is the number for the last terminal in an inter-register communications system.

IRC # OF RETRIES

The standard setting will be acceptable here, unless a specialist environment is to be designed. This feature controls the number of requests to consolidate a terminal before failure is announced.

PRINT/DISPLAY DECIMAL POSITION

This is the number of decimal places the system will use. It is assumed in the UK to be 2 decimals

SEND PLU DESCRIPTOR WHEN POLLED

This will send in addition to the normal information, the PLU description, when polled by a P.C.

PASSWORD (0000 = NO PASSWORD)

Each of the reporting areas can be password protected provided management restriction

REG# HOLDS TIME IN/OUT DATA

The time clock, labour hours worked and costing analysis feature can be operated on any terminal however the data is held centrally on one cash register.

REG# HOLDS CHECK TRACKING DATA

The four check tracking billing files can be operated on any terminal. The files however are stored centrally, normally on terminal 1 (the master). On a more tailored system this can be changed so that each tracking file is stored on a different terminal, the information will be available for central use.

REG# HOLDS KP GLOBAL ORDER#

The order number printed on kitchen order tickets can be the register number followed by a consecutive number of can be held centrally and be a system consecutive number this is referred to as a global order number.

ROM FILE DOWNLOAD PASSWORD

The flash ROM can be transmitted across the network using a S-mode option this is the password

PRINTER DRIVER SELECTIONS

This is used to customise existing printer formats or to add generic printers to the system. There is normally no need to change this information. The only exception being, printing bitmap images where the initialisation code should be deleted for the appropriate printer.

S-MODE PROGRAMMING MENU **L1**

1. SELF TESTS
2. MEMORY CLEAR
3. MEMORY ALLOCATION DISPLAY
4. KEYBOARD KEY RELOCATION
5. SYSTEM OPTIONS
- 6. PRINTER DRIVER SELECTIONS**
7. SERIAL PORT DEVICE SELECTIONS
8. DEFINE SERIAL PORT PARAMETERS
9. S-MODE PROGRAM SCAN PRINTING
10. SYSTEM PASSWORD
11. SUPER MACRO SCAN
12. ROM FILE DOWNLOAD

▼ ENTER PAGE UP/DN ↑↓

PRINTER DRIVER SELECTIONS **L1**

PRINTER TYPE	START	CANCEL
SAM SRP-100	INITIALIZE	1B40
SAM SRP-250	COMPRESSED	
SAM SRP-300	RED/REV	
CITIZEN 3541	EXPANDED	1B2121
CITIZEN 810	BOLD	1B2101
CITIZEN 230	UNDERLINE	
EPSON T88-2	LONG FEED	1B64
EPSON U200	FULL CUT	1B69
EPSON U295	PART. CUT	1B69
EPSON U300	STANDARD	
EPSON U325	LOGO	

▼ ESC ENTER PAGE UP/DN ↑↓

PRINTER DRIVER DEFINITIONS

PRINTER TYPE

Common printer types have been defined, SAMSUNG, CITIZEN, EPSON etc, These need no modification. The system does have some custom printer types available for technicians to allocate their own settings.

PRINTER TASK, INTIALISE COMPRESS

This is the definition area of the tasks the printer can perform such as bold, underline etc. This is a fixed field and is used to label the start and cancel codes. The only amendment that need be made is when a bitmap graphics image is to be printed and then, the initialisation code would be deleted on the appropriate printer, or an alternatively is when a generic printer is to be allocated to the system.

START CODE

This code relates to the Printer task and is input from your own printer manual when defining a custom printer.

END CODE

This code relates to the Printer task and is input from your own printer manual when defining a custom printer.

SERIAL PORT DEVICE SELECTIONS

The serial ports are the physical connections on the terminal, three as standard with a maximum of seven available. The following section defines which type of peripheral will be attached to the port

S-MODE PROGRAMMING MENU		L1
1.	SELF TESTS	
2.	MEMORY CLEAR	
3.	MEMORY ALLOCATION DISPLAY	
4.	KEYBOARD KEY RELOCATION	
5.	SYSTEM OPTIONS	
6.	PRINTER DRIVER SELECTIONS	
7.	SERIAL PORT DEVICE SELECTIONS	
8.	DEFINE SERIAL PORT PARAMETERS	
9.	S-MODE PROGRAM SCAN PRINTING	
10.	SYSTEM PASSWORD	
11.	SUPER MACRO SCAN	
12.	ROM FILE DOWNLOAD	
▼		ENTER PAGE UP/DN ↑↓

SERIAL PORT DEVICE SELECTIONS			L1
PORT	DEVICE	PRINTER TYPES	
PORT#1	DISABLE	SAM SRP-100	
PORT#2	PRINTER	SAM SRP-250	
PORT#3	VIDEO	SAM SRP-300	
PORT#4	POLLING	CITIZEN 3541	
PORT#5	SCALE	CITIZEN 810	
PORT#6	SCANNER	CITIZEN 230	
PORT#7	EFT TERMNAL	EPSON T88-2	
	CHANGER	EPSON U200	
	POLE DISPLAY	EPSON U295	
	LIQUOR	EPSON U300	
		EPSON U325	
→		→	
ESC ENTER PAGE UP/DN ↑↓			

SERIAL PORT SELECTIONS - DEFINITIONS

PORT

This is the number of the physical port located on the terminal. There are three as standard with a maximum of seven

DEVICE

This is the peripheral which will be connected to the port. The following options can be chosen.

- Disable** - The port is not active
- Printer** - The port will be used to operate a printer, you are then presented with a list of Printer types, all of which are pre-programmed with Driver setting.
- Video** - This is a linked Kitchen Video System for the display of products
- Polling** - This is the on-line computer link.
- Scale** - This links to an approved scale for weighted items
- Scanner** - This option enables a barcode scanner
- EFT Terminal** - This option links an approved Electronic Fund Transfer Terminal
- Changer** - This option allows a coin changer to be connected.
- Pole Display** - This option allows a pole remote display to be connected.

PRINTER TYPES

When a printer is selected in device, this displays the options / chosen printer model

DEFINE SERIAL PORT PARAMETERS

This is used to define the baud rate etc of a peripheral linked to the serial port, i.e. speed of scanning and other required settings

S-MODE PROGRAMMING MENU		L1
1.	SELF TESTS	
2.	MEMORY CLEAR	
3.	MEMORY ALLOCATION DISPLAY	
4.	KEYBOARD KEY RELOCATION	
5.	SYSTEM OPTIONS	
6.	PRINTER DRIVER SELECTIONS	
7.	SERIAL PORT DEVICE SELECTIONS	
8.	DEFINE SERIAL PORT PARAMETERS	
9.	S-MODE PROGRAM SCAN PRINTING	
10.	SYSTEM PASSWORD	
11.	SUPER MACRO SCAN	
12.	ROM FILE DOWNLOAD	
▼	ENTER PAGE UP/DN ↑↓	

SERIAL PORT#1 PARAMETER SELECTIONS L1	
PORT DESCRIPTION	PORT1
BAUD RATE	009600•
PARITY	NONE•
DATA BITS	8•
STOP BITS	1•
RETRIES	00
FEED LINES BEFORE PRINTING	00
FEED LINES AFTER PRINTING	07
PRINT BITMAP?	N
LOGO SIZE (0-3)	0
LINES ON "HARD" SLIP	00
CUTTING AFTER PRINTING?	Y
ESC Y/N ENTER PAGE UP/DN ↑↓←→	

SERIAL PORT PARAMETERS - DEFINITIONS

PORT DESCRIPTION

This is an area in which you can type your own description of the task the port is carrying out, i.e. SHOP PRINTER, HAND SCANNER etc.. This description is for your own reference purposes.

BAUD RATE

This is the Baud Rate of the device, the communications speed of the peripheral

DATA BITS

This is a standard peripheral definition, the information is normally supplied with the device

STOP BITS

This is a standard peripheral definition, the information is normally supplied with the device

RETRIES

This is the number of attempts that will be made to communicate with a device before failure is declared the default settings are satisfactory for most commonly used peripherals.

FEED LINES BEFORE PRINTING / AFTER PRINTING

This the number of lines to be fed before or after the printing is started, this will make the receipt longer, helping format the ticket for non cutter printers.

PRINT BITMAP?

This allows printing of the previously downloaded graphics logo if the option has been defined as available within the memory allocation. Note the initialisation code for the graphics printer should be deleted using s-mode option, printer driver selections

LOGO SIZE (0 – 3)

This relates to the P.C. downloaded bit map image, each number relates to a different print format for the image.

LOGO SIZE	FORMAT	LOGO SIZE	FORMAT
0	NORMAL	1	DOUBLE WIDTH
2	DOUBLE HEIGHT	3	QUADRUPLE

LINES ON “HARD” SLIP

This is the number of lines that can be printed on a loose paper printer, before a prompt for the next page appears

CUTTING AFTER PRINTING?

When a printer has the capabilities of auto cut, this option will decide if that feature is to be used, i.e. for receipts it is commonly set to yes, however detail journal printers do not require this option

S-MODE PROGRAM SCANS

Programmed information can be sent to a printer so that a hard copy can be produced. This option is ideal for keeping records of your machines settings, these can then be stored for future reference.

S-MODE PROGRAMMING MENU	L1
<ul style="list-style-type: none">1. SELF TESTS2. MEMORY CLEAR3. MEMORY ALLOCATION DISPLAY4. KEYBOARD KEY RELOCATION5. SYSTEM OPTIONS6. PRINTER DRIVER SELECTIONS7. SERIAL PORT DEVICE SELECTIONS8. DEFINE SERIAL PORT PARAMETERS9. S-MODE PROGRAM SCAN PRINTING10. SYSTEM PASSWORD11. SUPER MACRO SCAN12. ROM FILE DOWNLOAD	
▼	ENTER PAGE UP/DN ↑↓

S-MODE PROGRAM SCAN PRINTING	L1	
<table border="1"><tr><td><ul style="list-style-type: none">1. MEMORY ALLOCATION2. SYSTEM OPTIONS3. PRINTER DRIVER SELECTIONS4. SERIAL PORT DEVICE SELECTIONS5. DEFINE SERIAL PORT PARAMETERS</td></tr></table>		<ul style="list-style-type: none">1. MEMORY ALLOCATION2. SYSTEM OPTIONS3. PRINTER DRIVER SELECTIONS4. SERIAL PORT DEVICE SELECTIONS5. DEFINE SERIAL PORT PARAMETERS
<ul style="list-style-type: none">1. MEMORY ALLOCATION2. SYSTEM OPTIONS3. PRINTER DRIVER SELECTIONS4. SERIAL PORT DEVICE SELECTIONS5. DEFINE SERIAL PORT PARAMETERS		
ESC ENTER PAGE UP/DN ↑↓		

S-MODE PROGRAM SCANS

MEMORY ALLOCATION

Print the definitions of the systems features and file maximums

SYSTEM OPTIONS

This prints the most basic of features such as terminal number and IRC (inter register communications) settings

PRINTER DRIVER SELECTIONS

This print out shows how technicians have customised printers.

SERIAL PORT DEVICE SELECTIONS

This prints the function of each of the physical ports listing the peripheral type connected.

DEFINE SERIAL PORT PARAMETERS

This prints the configuration of the ports, communication speed and unique settings

SYSTEM PASSWORD

The terminal can be restricted to the most basic of register uses. Using the employee authority password restriction for manager functions. It is possible by mistake to restrict access for yourself to programming. To prevent this the system has an in-built master password. When used as an employee code, by signing on with the EMPLOYEE# key in register mode this will allow access to all features enabling the user to program out the inappropriate restriction that had inadvertently been programmed. This password should be programmed and a record of the number kept when authority restrictions are used. Alternatively the default setting of 9999 can used if password override is required.

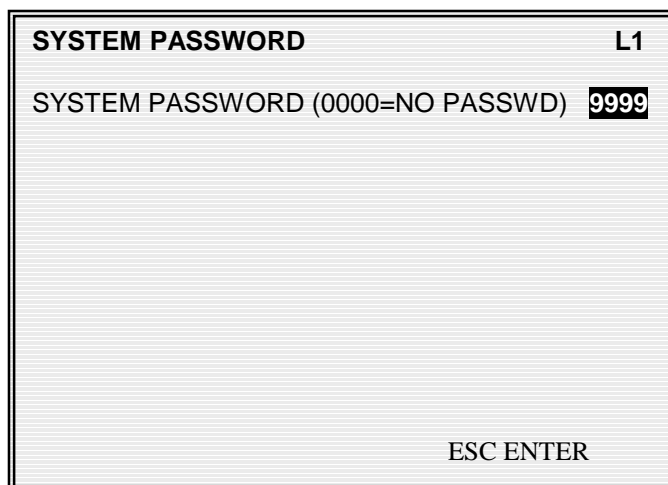
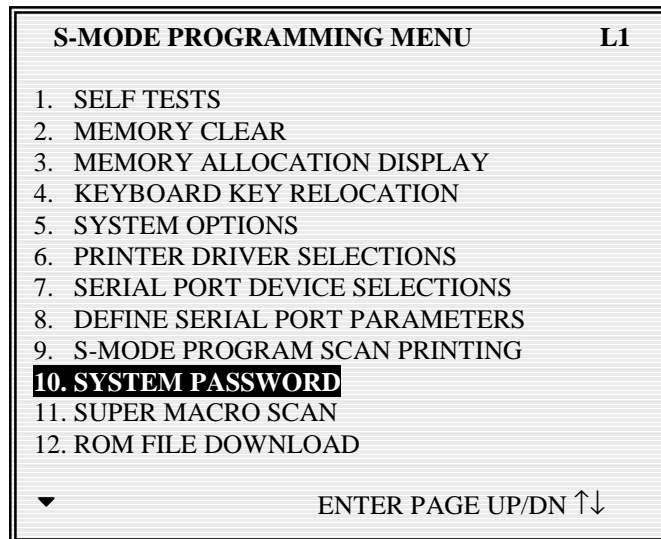

SUPER MACRO SCAN

The super macro file size is defined by the memory allocation sequence. This determines how many keystrokes can be stored in this section once the maximum limit has been stored wrap round reporting will begin i.e. line by line replacement of the oldest data. The super macro file acts as the terminal's log file recording all key pressing that are taking place. This section always has that information to be printed.

S-MODE PROGRAMMING MENU	L1
<ul style="list-style-type: none">1. SELF TESTS2. MEMORY CLEAR3. MEMORY ALLOCATION DISPLAY4. KEYBOARD KEY RELOCATION5. SYSTEM OPTIONS6. PRINTER DRIVER SELECTIONS7. SERIAL PORT DEVICE SELECTIONS8. DEFINE SERIAL PORT PARAMETERS9. S-MODE PROGRAM SCAN PRINTING10. SYSTEM PASSWORD11. SUPER MACRO SCAN12. ROM FILE DOWNLOAD	
▼	ENTER PAGE UP/DN ↑↓

SUPER MACRO SCAN	L1	
<table border="1"><tr><td><ul style="list-style-type: none">1. SUPER MACRO DISPLAY2. SUPER MACRO PRINTING</td></tr></table>		<ul style="list-style-type: none">1. SUPER MACRO DISPLAY2. SUPER MACRO PRINTING
<ul style="list-style-type: none">1. SUPER MACRO DISPLAY2. SUPER MACRO PRINTING		
ESC ENTER PAGE UP/DN ↑↓		

ROM FILE DOWNLOAD

This is used to transmit a PC downloaded flash ROM from the master terminal to the slaves within the system. (see the technical appendix for the PC ROM download procedure)

CAUTION: After completing this section you must then reset all programmed information, back to the factory default settings using the program reset procedure

This will erase the existing ROM and transmit a new flash ROM (which has been download from the P.C.) down the IRC network, Please consult the technical appendix for P.C. Flash ROM download procedures to transmit the rom from the P.C. When the ROM is transmitted only those set to receive will be amended, this will have no effect on any machines in the system not set.

TO PREPARE RECEIVING TERMINALS

1. Turn the power switch located on the right side of the register to the **OFF** position.
2. Turn the key lock to the **S-MODE** position (one position clockwise from the **PGM** key lock position).
3. Press and hold the key position where the **CASH** key is located on the default keyboard layout.
4. Continue to hold the **CASH** key whilst turning the power switch to the **ON** position. (see figure 1)
5. Press each of the four corner keys
TOP LEFT, BOTTOM LEFT, TOP RIGHT, BOTTOM RIGHT (see figure 2)
6. The screen will say download and is now waiting for the download procedure to be activated on the transmitting terminal.

NOTE: Please carry out an initial all program clear after transmitting the ROM

Figure 1.

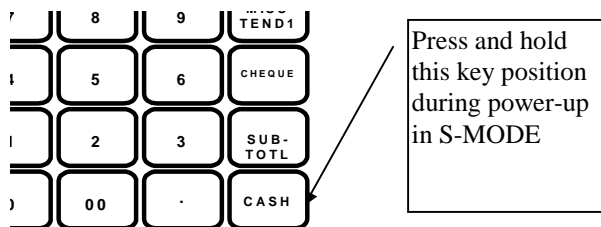

1st Figure 2. 3rd

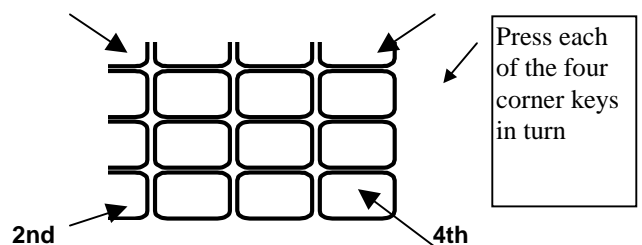

ROM FILE DOWNLOAD

TO PREPARE DOWNLOADING TERMINAL

This is used to transmit a PC downloaded flash ROM from the master terminal to the slaves within the system. (see the technical appendix for the PC ROM download procedure) This menu option is password protected with a default of 9999 the password can be change using S-MODE, SYSTEM OPTIONS settings.

The password can be found in S-mode system options

S-MODE PROGRAMMING MENU **L1**

1. SELF TESTS
2. MEMORY CLEAR
3. MEMORY ALLOCATION DISPLAY
4. KEYBOARD KEY RELOCATION
5. SYSTEM OPTIONS
6. **PRINTED PASSWORD : 0000**
7. SERIAL PORT PARAMETERS
8. DEFINE SERIAL PORT PARAMETERS
9. S-MODE PROGRAM SCAN PRINTING
10. SYSTEM PASSWORD
11. SUPER MACRO SCAN
- 12. ROM FILE DOWNLOAD**

▼ ENTER PAGE UP/DN ↑↓

DOWNLOADING...

ADDRESS (00xxxxxx)

████████████████████

30% COMPLETED

LOAD DEFAULT MESSAGES

This will revert back to default text any messages which have been changed from their original settings

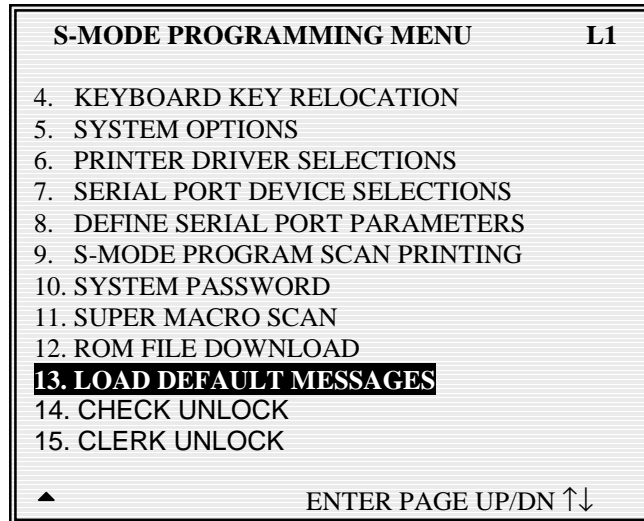

ERROR MESSAGES

These are the onscreen display prompts warning the operator of mis-operations. Following is a list of the standard error messages,

SYSTEM DESCRIPTORS

These are the onscreen and reporting messages designed to assist the operator. Following is a list of the standard error messages.

DEFAULT ERROR MESSAGES

NO.	DESCRIPTION	NO.	DESCRIPTION
1	(NOT USE)	111	NEGATIVE CARD
2	(NOT USE)	112	LINKED STATUS REQUIRED
3	AMOUNT REQUIRED	113	RETURN TO X-MODE
4	BAD VALUE	114	ERROR - SLIP PAPER
5	BUFFER FULL	115	LOCAL PRINTER REQUIRED
6	BUFFER EMPTY	116	MODE ERROR
7	BUSY	117	SET TIME&DATE IS DECATIVATED
8	BAD COMMAND	118	EMPLOYEE SHOULD BE DIFFERENT
9	CASH DECALATION REQUIRED	119	TRANSFER NOT ALLOWED
10	CASH-IN-DRAWER EXCEEDED	120	REQ GALLONAGE AMOUNT
11	CHECK# ASSIGNED AUTO	121	AVAILABLE ONLY IN CHECK
12	CHECK# REQUIRED !	122	SPLIT THIS ITEM NOT POSSIBLE
13	CONDIMENT REQUIRED!	123	FUNCTION KEY NOT INCLUDED
14	CRC ERROR	124	ERROR POST TENDER
15	DUPLICATE!	125	NO TRACKING DATA IN THIS REG
16	ANALYSIS1/2/3	126	NO TIME KEEP DATA IN THIS REG
17	ENTER EMPLOYEE CODE	127	MULTIPLICATION LIMIT EXCEEDED
18	ENTER EMPLOYEE #	128	TAB OF FIELD2 TOO BIG
19	ENTER GUEST COUNT	129	NON-PLU CODE RANGE OVER
20	ENTER SEAT#	130	TARE ENTRY NOT ALLOWED
21	ENTER TABLE#	131	MISC TEND REQUIRED
22	ENTRY REQUIRED	132	SAME CHECK TRACK REQUIRED
23	ERROR	133	NOT SCALEABLE PLU
24	ERROR JAM	134	EJ BUFFER FULL
25	TABLE NUMBER IN USE	135	MUST BE START<=END IN RANGE
26	HALO OVER!	136	RANGE OVERLAP
27	ILLEGAL KEY SEQUENCE	137	FINAL END SHOULD BE 9 OR 99
28	IN USE!	138	NOT PLU
29	INACTIVE!	139	NOT WLU
30	INPUT QTY	140	PRINT KEY REQUIRED
31	KITCHEN PRINTER FAILURE	141	SURCHARGE NOT ALLOWED
32	MANAGER REQUIRED	142	DECIMAL ENTRY REQUIRED
33	MANAGER OVERRIDE REQUIRE	143	SYSTEM REG# REQUIRED
34	MEMORY FULL	144	TRAINING EMP FILE# REQUIRED
35	NEGATIVE	145	TIME IN/OUT REG# REQUIRED
36	NO CHECK#	146	CHECK TRACKING REG# REQUIRED
37	NO DATA	147	ELECTRONIC JOURNAL INACTIVE
38	NO DRAWER!	148	CHEQUE ENDORSEMENT REQUIRED
39	NO MANUAL ENTRY	149	EFT TERMIANL TRANS. KEY ERROR
40	NO PAPER	150	CARD ERROR
41	NO PLU!	151	PRINTER OFFLINE
42	NON ADD# REQUIRED	152	KV OFFLINE
43	NOT DISCOUNTABLE	153	NO RELOCATABLE KEY
44	NOT PROGRAMMED!	154	CLERK KEY ERROR
45	NOT READY!	155	ENFORCE ACTUAL INVENTORY
46	NOT ZERO	156	AUTHORITY LEVEL NOT LINKED
47	OFF LINE!	157	WEIGHT IS ZERO
48	OPEN DRAWER	158	STOCK IS NOT ZERO
49	P/BAL REQUIRED	159	CLEAR CAN NOT BE REMOVED
50	PAPER END	160	ENTER CAN NOT BE REMOVED
51	RANGE OVER	161	YES/NO CAN NOT BE REMOVED
52	REMOVE PAPER	162	THIS NUMERIC CAN'T BE REMOVED
53	SCALE FAIL!	163	INCORRECT CODE

DEFAULT ERROR MESSAGES

54	SCALE REQUIRED!	164	SOFT CHECK ONLY
55	SINGLE ITEM!	165	INACTIVE PLU
56	SUBTOTAL REQUIRED	166	MULTIPLE DISCOUNT NOT ALLOWED
57	SYSTEM ERROR	167	NEW CHECK OPENED
58	TARE# REQUIRED	168	NO MORE SPLIT TENDER ALLOWED
59	TRAY SUBTOTAL REQUIRED!	169	CHECK POLE DISPLAY
60	VALIDATION REQUIRED	170	MUST MAX.NONTAXABLE<=BRK PNT1
61	WASTE REQUIRED!	171	MUST BRK PNT n <= BRK PNT n+1
62	WRONG EMPLOYEE	172	NOT ALLOWED WITH OPEN ORDERS
63	SIGN OFF REQUIRED	173	NOW POLLING !!
64	ZERO AMOUNT	174	INCORRECT TARE WEIGHT
65	PRICE LEVEL MISMATCH	175	MIX AND MATCH ERROR
66	OVERRIDE NOT ALLOWED	176	CLERK INTERRUPT ERROR
67	WRONG SEQUENCE	177	CHECK OPENED NO DATA
68	WRONG COMMAND	178	NO CLERK BUFFER IN THIS REG
69	WRONG FILE NO		
70	WRONG ITEMIZER		
71	UNDER TEND NOT ALLOWED		
72	OVER TEND NOT ALLOWED		
73	CHECK TRACKING ERROR		
74	USING		
75	PLU NOT ALLOWED		
76	CONDIMENT PLU NOT ALLOWED		
77	NON-CONDIMENT PLU NOT ALLOWED		
78	FUNCTION KEY NOT ALLOWED		
79	THIS KEY NOT ALLOWED		
80	NO FUNCTION KEY		
81	NO PROGRAMMABLE KEY		
82	X/TIME REQUIRED		
83	INVALID AUTHORITY LEVEL		
84	TIME IN REQUIRED		
85	SIGN ON REQUIRED		
86	MEMORY NOT ALLOCATED		
87	THIS EMP. RPT MUST BE CLEARED		
88	ERROR STATUS		
89	ERROR VALUE		
90	ERROR SYSTEM OPTION		
91	ERRRR EMPLOYEE		
92	ERROR TABLE NO		
93	SCALE MOTION		
94	OVER WEIGHT		
95	UNDER WEIGHT		
96	PROMO NOT ALLOWED		
97	WASTE NOT ALLOWED		
98	NO FOOD STAMP AMOUNT		
99	DECIMAL ENTRY NOT ALLOWED		
100	SPLIT PRICING NOT ALLOWED		
101	VOID MODE IS DEACTIVATED		
102	JOB CODE REQUIRED		
103	JOB CODE CHANGE NOT ALLOWED		
104	PUSH BUTTON ENTRY REQUIRED		
105	EMPLOYEE CODE NOT LINKED		
106	TENDERING IS NOT ALLOWED		
107	OVER REGULAR HOURS PER WEEK		
108	MUST <= LINE# PER TRANSACTION		
109	MUST >= LINE# PER SOFT CHECK		
110	NO STOCK PLU		

DEFAULT SYSTEM DESCRIPTORS

NO.	DESCRIPTION	NO.	DESCRIPTION
1	SUN	55	PAYMENT
2	MON	56	HOME AMT
3	TUE	57	FSCRT
4	WED	58	FS EXMT
5	THU	59	SCALE CANCEL
6	FRI	60	TIP PAID OUT
7	SAT	61	TIP DECLARED
8	MGR	62	TAXABLE 1
9	TAXES	63	TAXABLE 2
10	TOTAL	64	TAXABLE 3
11	FSTAX	65	TAXABLE 4
12	FSTTL	66	TAXABLE 5
13	FSCNG	67	TAXABLE 6
14	DATE	68	TAX1 AMT
15	TIME	69	TAX2 AMT
16	NO.	70	TAX3 AMT
17	CASH	71	TAX4 AMT
18	CHEQ	72	TAX5 AMT
19	MISC	73	TAX6 AMT
20	REG	74	VAT1 AMT
21	PLU#	75	VAT2 AMT
22	PBAL	76	VAT3 AMT
23	SEAT#	77	VAT4 AMT
24	ESC	78	VAT5 AMT
25	TBL	79	VAT6 AMT
26	GST	80	EXEMPT TAX1
27	EMPL.	81	EXEMPT TAX2
28	FOR	82	EXEMPT TAX3
29	AMOUNT REQUIRED	83	EXEMPT TAX4
30	*****TRAINING*****	84	EXEMPT TAX5
31	TIME CLOCK – IN	85	EXEMPT TAX6
32	TIME CLOCK – OUT	86	TAX TOTAL
33	EMPLOYEE SIGN ON	87	NO SEAT
34	EMPLOYEE SIGN OFF	88	POST TENDER
35	DECLARE CASH TIPS	89	SYSTEM
36	↑↓↔ ENT	90	BALANCE
37	↑↓↔ ENT DONE	91	CHECK#
38	↑↓↔ ENT X/TM	92	CLOCK OUT
39	↑↓↔ ENT DONE X/TM	93	CLOSED
40	ADD CHECKS FOR PAYMENT	94	PRICE/HALO
41	** NOT CLOSED CHECKS **	95	DESCRIPTOR
42	ENTER NEW SEAT#	96	LINK GROUP
43	EMPLOYEE	97	LINK STATUS
44	AMT DUE	98	CHANGE RATE
45	CHANGE	99	FOREIGN AMT
46	JOB CODE	100	REG MODE
47	SUMMARY	101	VD MODE
48	OUT FOR BRK	102	MGR MODE
49	OUT	103	CONV
50	OPERATOR	104	GAS CNT
51	NON-ADD#	105	GAS AMT
52	INPUT QTY	106	ORDER#
53	ENTER TIME:	107	REPRINT
54	TRANS VD	108	GROUP0
		109	DELETED PLU

UNLOCK PROCEDURES

This will reset an locked operational checks or clerk interrupt details. This must be performed on the terminal set to store the data in the s-mode system option settings.



CHECK UNLOCK

Used in the unlikely event that an open check track number becomes locked and inoperable

CLERK UNLOCK

Used in the unlikely event that an open clerk interrupt buffer becomes locked and inoperable.



P-MODE

PLU – PROGRAMMING

During PLU Programming, each PLU is assigned a descriptor, price or prices and a few unique options.

The remainder of the PLU options are determined by linking the individual PLU to a PLU Status Group. The PLU Status Group contains all of the detailed programming option selections that might be assigned to a product. Separate PLU Status Groups are defined to accommodate the needs of groups of PLUs. Like PLUs, the total number of PLU Status Groups is determined by memory allocation.

NOTE When programming PLUs the cursor by defaults starts at the group link input flag using a system flag this can be change so that entry starts at the price field, using the page up/down keys to scroll through records this makes bulk prices changes faster to program.

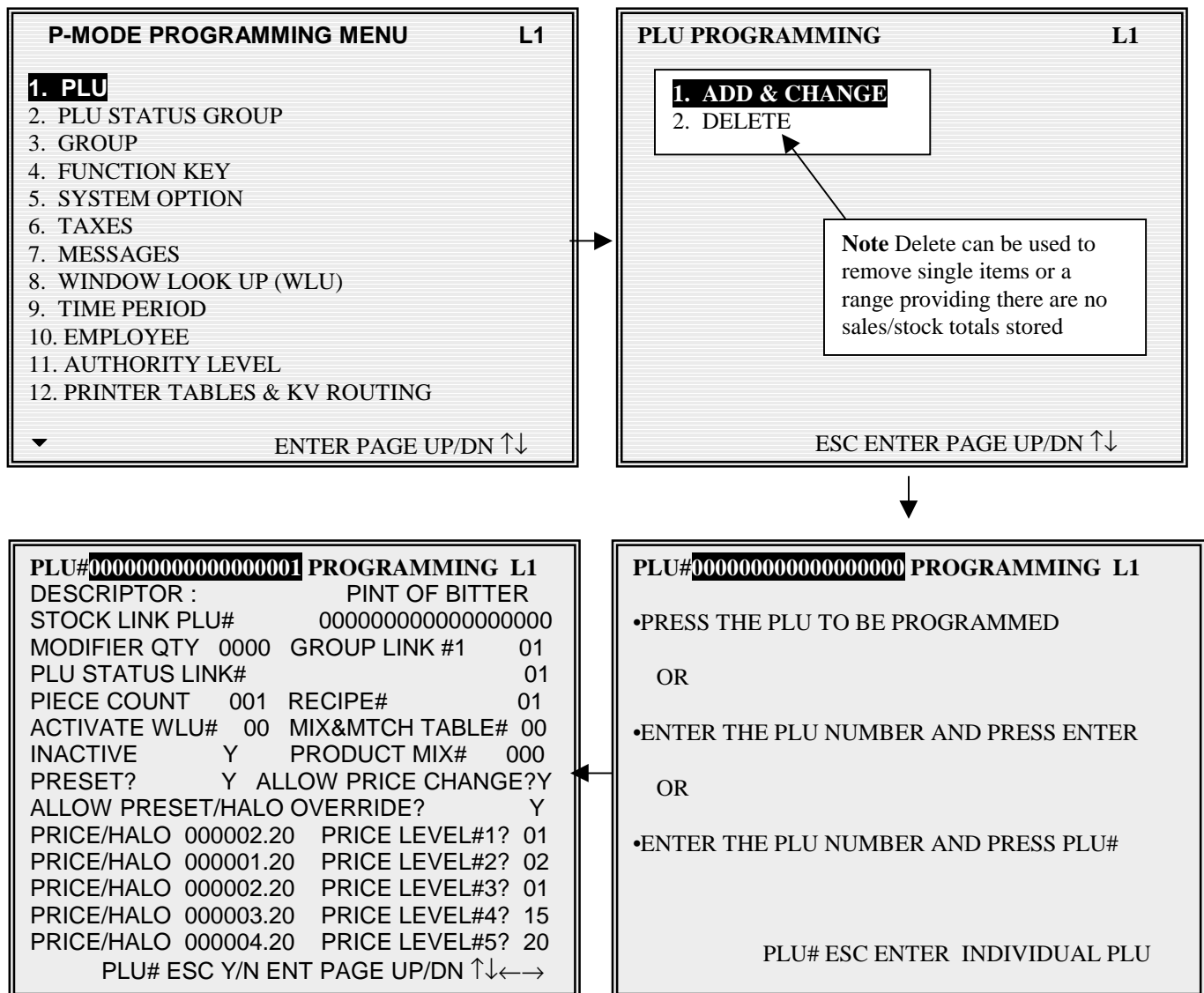

PLU – DEFINITIONS

DESCRIPTOR

This is the name of the saleable item, which will appear on receipts and reports.

STOCK LINK PLU#

It is possible when managing stock, the principle of buy one reduce one from stock that a number of items may need to reduce from the same stock item for example half pints of beer from a print. This is the item from which the stock will be reduced after the sale of this code number

MODIFIER QTY

This works in conjunction with the stock link PLU flag determining how many units are to be reduced from the main stock item. The field consists of two decimal places for example 50 would result in 0.50 being reduced from the stock of the item program within the stock link PLU field.

GROUP LINK #1

This field is used to provide the first type of sales analysis by category i.e. Beer, Lagers

PLU STATUS LINK#

This is the programming for the status group link. Providing an en-masse program procedure for common system flags

PIECE COUNT

This is the number of units to be used from a product mix group, case, as this product is sold. For example a jumbo burger, requires 2 units of the Burger bought by the Dozen product mix group This field is then set to 2, so that for each item sold 2 burgers out of a case of 12 are recorded

RECIPE#

This links to the ingredient inventory, so that when the product is sold, the quantities of each ingredient used are subtracted from stock for the allocated recipe and the appropriate sub recipes.

ACTIVATE WLU#

When a WLU# key is not being activated by a WLU# key, it can be attached to the PLU. This is used mainly when the window applies solely to a product i.e. Cooking instructions etc..

MIX&MATCH TABLE#

This is the promotion discount table, when the product or a mix of products, allocated to the same table are sold the appropriate discount information from the mix and match table will be subtracted.

INACTIVE

This prevents the product from being sold, without deleting therefore still retaining accumulated product sales data.

PLU – DEFINITIONS

PRODUCT MIX#

This works in conjunction with the piece count to track the unit and case usage of an item, each product can be programmed with the number of pieces used from an outer, ie the number of bottles from a case. The piece count would control the number of bottles and the product mix group would control the description of the item and the number of units in case. In this field you would link the item to the product mix group.

PRESET?

This determines whether the product is a pre-set or open price.

ALLOW PRESET/HALO OVERRIDE?

This allows the operator to either manually enter over a pre-set priced item or to override a maximum sale limit. This works per PLU, with each product having individual restriction. If global restriction is required change the setting in systems options

PRICE/HALO 1 - 5

This is either the pre-set price of an item, or the maximum sale amount of an open product.

PRICE LEVEL#1 - 5

Entered here is the price level, for each product. There are 5 different prices per product, with up to twenty price levels available to be allocated. This allows the user to create a matrix of PLUs and Prices each accessed by one of the twenty price keys. When the price key is priced the product is then checked to determine if that price level (1-20) exists in any one of the five prices available. The standard is two prices per product set to price 1 and 2 this is generated as standard. A product price level sales report is available showing the total quantity and value sold per price and overall per product also a total for each price. This feature is not related to the five keyboard levels, they work independently

PLU STATUS GROUP – PROGRAMMING

PLU Status Groups allow memory to be used more efficiently. In most applications, large groups of PLUs are set with many identical options, while the PLU number, descriptor and price are unique. On the PLU Programming each PLU is assigned a descriptor, price or prices and a few unique options. The remainder, of the PLU options are determined by linking the individual PLU to a PLU Status Group. The PLU Status Group contains all of the detailed programming selections that might be assigned to an individual PLU. Separate PLU Status Groups can be set up to accommodate the needs of groups of PLUs. Like PLUs, the total number of PLU Status Groups is determined by memory allocation.

P-MODE PROGRAMMING MENU	L1
1. PLU	
2. PLU STATUS GROUP	
3. GROUP	
4. FUNCTION KEY	
5. SYSTEM OPTION	
6. TAXES	
7. MESSAGES	
8. WINDOW LOOK UP (WLU)	
9. TIME PERIOD	
10. EMPLOYEE	
11. AUTHORITY LEVEL	
12. PRINTER TABLES & KV ROUTING	
▼	ENTER PAGE UP/DN ↑↓

PLU STATUS GROUP# 1 PROGRAMMING L1	
DESCRIPTOR :	BAR PROGRAM
	1 2 3 4 5 6
1. TAXABLE BY RATES?	Y N N N N N
2. GROUP LINK #2	01
3. GROUP LINK #3	51
4. ARE PLUS IN THIS GROUP INACTIVE?	Y
5. IS PLU A CONDIMENT?	N
6. COMPULSORY CONDIMENT ENTRY?	N
7. IS PLU SINGLE ITEM?	N
8. IS PLU NEGATIVE?	N
9. IS PLU HASH?	N
10. DOES PLU USE GALLONAGE?	N
▼	ESC Y/N ENTER PAGE UP/DN ↑↓←→

PLU STATUS GROUP# 1 PROGRAMMING L1	
11. IS PLU FOOD STAMP ELIGIBLE?	N
12. IS PLU MEMO?	N
13. IS PLU SCALEABLE?	N
14. AUTO SCALE ON THIS PLU ?	N
15. AUTO TARE# (0-20)	00
16. STOCK PLU?	N
17. LINK PLU#	000000000000000000
18. NEGATIVE INVENTORY?	Y
19. ALLOW PROMO?	Y
20. ALLOW WASTE?	Y
21. ALLOW DISCOUNT?	Y
22. ALLOW SURCHARGE?	Y
◆	ESC Y/N ENTER PAGE UP/DN ↑↓←→

PLU STATUS GROUP# 1 PROGRAMMING L1	
23. COMPULSORY VALIDATION	N
24. IS NON-ADD# COMPULSORY?	N
25. PRINT ON KV?	N
26. KITCHEN VIDEO GROUP #	00
27. COLOR TO DISPLAY ON KV (0-31)	00
28. PRINT ON KP?	Y
	1 2 3 4 5 6 7 8 9
29. PRINT ON KP GROUP#	Y N N N N N N N N
30. PRINT RED ON KITCHEN PRINTERS?	Y
31. PRINT RED ON RECEIPT?	N
32. PRINT ON RECEIPT?	Y
33. PRINT ON JOURNAL?	Y
◆	ESC Y/N ENTER PAGE UP/DN ↑↓←→

PLU STATUS GROUP – DEFINITIONS

TAXABLE BY RATES?

This applies the selected pre-programmed tax rate to this item

GROUP LINK #2

This field is used to provide the second sales analysis by category i.e. Draught Beers etc.

GROUP LINK #3

This field is used to provide the third sales analysis by category i.e. Wet, Dry sales etc.

ARE PLUS IN THIS GROUP INACTIVE?

This will disable the sale of a product. Ideal when totalisers are still being stored

IS PLU A CONDIMENT?

A condiment is a way of amending a product, either priced such as salad, (totals are treated the same as PLU sales) or zero priced such as cooking instructions. The print format changes, indenting to indicate the item that is a condiment. It is also not possible to sell a condiment without a normal PLU product being sold. I.e. no side salad without a main meal.

COMPULSORY CONDIMENT ENTRY?

This forces the entry of a condiment after the sale of an item, i.e. a steak may require cooking instructions to be entered immediately. This would be set to the normal PLU ensuring a condiment PLU is pressed directly after the sale.

IS PLU SINGLE ITEM?

This feature automatically finalises the sale when this product is sold, assuming a cash payment

IS PLU NEGATIVE?

This changes permanently the retail price of the item to a negative sale

IS PLU HASH?

This allows the sales quantity and values of an item to be treated differently, these are not added to the same financial totals as ordinary products. The totaliser to which the information is added are control by system programming, it will be required that you set these system options according to the specifications for your items. A H is show alongside the PLU on the PLU trading report to indicate the item is a HASH PLU (providing the PLU HASH option is set to include sales on the PLU report)

DOES PLU USE GALLONAGE?

Gallonage PLUs must be set as open PLUs. The PRICE/HALO must be set as the price per gallon (the price is set at three decimal places (\$1.299) Gallonage PLUs will report the gallons sold in the activity counter on the PLU report by dividing the PLU total by the price per gallon.

IS PLU FOOD STAMP ELIGIBLE?

This is an American feature where payment can be received by government food vouchers This ensures products are available for sale with payment by voucher

PLU STATUS GROUP – DEFINITIONS

IS PLU MEMO?

This enables all PLU information to be printed, but not calculated to totalisers, i.e. a description print

IS PLU SCALEABLE?

This allows the product to be a weighted item, and register the weight programmed.

AUTO SCALE ON THIS PLU?

If Y, is entered registrations of PLUs linked to this group will automatically multiply by the weight placed upon a scale connected to the register.

AUTO TARE# (0 - 20)

If Y, is entered the tare# indicated here will automatically subtract the weight from the scale.

STOCK PLU?

Is this product to be included in the stock taking ? i.e. will stock / deliveries be entered for this product.

NEGATIVE INVENTORY?

This converts the positive stock counts entered for ingredients into negative totals.

ALLOW PROMO?

Is this product available for promotion sales?

ALLOW WASTE?

Is this product allowed to register stock wastage totals entered by the operator?

ALLOW DISCOUNT?

This controls whether a product is included when a monetary or percent discount is carried out.

ALLOW SURCHARGE?

This controls whether a product is included when a monetary or percent premium is carried out.

COMPULSORY VALIDATION

If this product is sold, validation printing is required. (Available only on a printer with a validation sensor)

IS NON-ADD# COMPULSORY?

This forces the operator to enter a reference number after the sale of this product

PRINT ON KV?

This determines whether the product is printed on the Kitchen Video display

PLU STATUS GROUP – DEFINITIONS

COLOR TO DISPLAY ON KV (0-31)

This is the colour in which the information is to be displayed on the Video System

PRINT ON KP?

If this is set to Y the item is available for print on upto 9 kitchen printer routes, required for use with the PRINT key.

PRINT ON KP GROUP# 1 - 9

This is the group for the items to be printed on the kitchen printer, for example all bar items may be in group 1 and the food in group 2. The kitchen printer setup will then determine which physical printer prints, which group at which times.

PRINT RED ON KITCHEN PRINTERS?

Print products on the order in red. This is designed for Red/Black Printers, a thermal printer will invert

PRINT RED ON RECEIPT?

Print products on the receipt in red. This is designed for Red/Black Printers, a thermal printer will invert

PRINT ON RECEIPT?

This controls the product printing on the receipt, a priced item with no price printing will still be included in the sale total.

PRINT ON JOURNAL?

This controls whether the product prints on the journal printer

DISPLAY ON THE REGISTER SCREEN?

This controls whether the product prints on the main register display.

PRINT ON GUEST CHECKS?

This controls the product printing on the bill, a priced item with will still be included in the sale total.

PRINT PRICE ON GUEST CHECKS?

This controls whether the product's retail price prints on the check bill, still to be included in total

PRINT PRICE ON RECEIPT/DETAIL?

This controls whether the product retail price prints on the receipt and detail journal printers

AUTO GRILL?

Items may be programmed as AUTO GRILL this ensures the item is sent to the printer immediately

AUTO GRILL KP GROUP #

This is the print group to be allocated to the printer programming to control where the item is printed

GROUP – PROGRAMMING

Groups are designated to accumulate PLU sales for reporting analysis. A PLU can store sales information in up to 3 groups.

Group Link #1 is set in PLU programming.

Group Links #2 and #3 are set in PLU Status Group programming.

This program allows you to set names to the groups that PLU sales will report to up to 99 groups are available.

P-MODE PROGRAMMING MENU	L1
<ol style="list-style-type: none"> 1. PLU 2. PLU STATUS GROUP 3. GROUP 4. FUNCTION KEY 5. SYSTEM OPTION 6. TAXES 7. MESSAGES 8. WINDOW LOOK UP (WLU) 9. TIME PERIOD 10. EMPLOYEE 11. AUTHORITY LEVEL 12. PRINTER TABLES & KV ROUTING 	
▼	ENTER PAGE UP/DN ↑↓

GROUP#1 PROGRAMMING		L1
DESCRIPTOR :	BAR AREA 1	
ADD TO GROUP TOTAL?	Y	
	1 2 3 4 5 6	
TAXABLE BY RATE FOR ANALYSIS2Y	N N N N N	
ESC Y/N ENTER PAGE UP/DN ↑↓←→		

GROUP – DEFINITIONS

ADD TO GROUP TOTAL?

This determines if the total sales for this category are to be included in the total of all group sales on the read and reset analysis reports. It requires that only one of the three group that an item is linked to is included in the group totals otherwise the figures will be inaccurate.

TAXABLE BY RATE FOR ANALYSIS2

If this option is set when the analysis 2 function key is used in REG mode the taxable status of the item no longer follows the normal PLU tax rate but is taxed at the rate programmed to this field

EXAMPLE GROUP STRUCTURING

PLUs 1- 10 are DRAUGHT BEERS items
 PLUs 11 – 20 are MINERALS items both the above linked to PLU status
 group 1 BAR
 Etc...
 PLUs 101 - 110 are STARTER items
 PLUs 111 – 120 are MAIN COURSE items both the above linked to PLU status
 group 2 FOOD

An analysis is required for each type of saleable product, also a total for the drink items and a total for food items, with an overall restaurant sales total

The following programming method would provide that analysis.

GROUPS	PROGRAMMING
1 - DRAUGHT BEERS	linked to PLUs 1– 10 using GROUP#1 field in PLU program
2 - MINERALS	linked to PLUs 11–110 using GROUP#1 field in PLU program
3 - STARTERS	linked to PLUs 101–110 using GROUP#1 field in PLU program
4 - MAIN COURSE	linked to PLUs 111 –120 using GROUP#1 field in PLU program
51 - DRINK SALES	linked to 1 – BAR PLU Status group using GROUP#2 field
52 - FOOD SALES	linked to 2 – FOOD PLU Status group using GROUP#2 field
76 - RESTRN TOTAL	linked to 1 - BAR PLU Status group using GROUP#3 field also linked to 2 - FOOD PLU Status group using GROUP#3 field

The group programming would be set so only groups less than 50 added into the group total ie all Draughts, Minerals etc.. whilst groups greater than 51 would not be added to the group total, therefore ensuring the total on the group sales read is always correct.

FUNCTION KEY – PROGRAMMING

Function key options vary by key, each feature is explained in the following pages. Function keys may exist on different levels of the keyboard, or they may only be accessed through WLUs, they may also be addressed by directly pressing the key, or by entering the function key code number.

P-MODE PROGRAMMING MENU		L1
1.	PLU	
2.	PLU STATUS GROUP	
3.	GROUP	
4.	FUNCTION KEY	
5.	SYSTEM OPTION	
6.	TAXES	
7.	MESSAGES	
8.	WINDOW LOOK UP (WLU)	
9.	TIME PERIOD	
10.	EMPLOYEE	
11.	AUTHORITY LEVEL	
12.	PRINTER TABLES & KV ROUTING	
▼	ENTER PAGE UP/DN ↑↓	

FUNCTION KEY # 0 PROGRAMMING	L1	FUNCTION KEY # 214 PROGRAMMING	L1
•PRESS THE KEY TO BE PROGRAMMED OR		DEFAULT DESC :	STORE CHK1
•ENTER THE KEY NUMBER AND PRESS ENTER OR		DESCRIPTOR :	HOLD RESTAUR
•PRESS ENTER TO VIEW A FUNCTION LIST OR		HALO (0:NO LIMIT)	00000.00
•PRESS THE WLU WHERE THE FUNCTION IS LOCATED AND SELECT THE APPROPRIATE FUNCTION		EXEMPT TAX :	1 2 3 4 5 6 N N N N N N
		ACTIVE IN X ONLY?	N
		COMPULSORY VALIDATION?	N
		NON-ADD# COMPULSORY?	N
		PRINT ON RECEIPT?	Y
		PRINT ON JOURNAL?	Y
		SERVICE OF NEGATIVE BALANCE IN X ONLY? N	
		HARD CHECK PRINTER # (0-40)	00
ESC WLU ENTER FUNCTION KEY		▼	ESC Y/N ENTER PAGE UP/DN ↑↓←→

FUNCTION KEY – LISTING

CODE	NAME	CODE	NAME	CODE	NAME
1	NUMERIC 1	70	MACRO PAUSE	139	MODIFIER4
2	NUMERIC 2	71	MACRO R (REG)	140	MODIFIER5
3	NUMERIC 3	72	MACRO S (S-MODE)	141	MODIFIER6
4	NUMERIC 4	73	MACRO SET (RECORD)	142	MODIFIER7
5	NUMERIC 5	74	MACRO VOID	143	MODIFIER8
6	NUMERIC 6	75	MACRO X	144	MODIFIER9
7	NUMERIC 7	76	MACRO Z	145	MODIFIER10
8	NUMERIC 8	77	MACRO1	146	NEXT RECORD
9	NUMERIC 9	78	MACRO2	147	#/NOSALE
10	NUMERIC 0	79	MACRO3	148	P/BAL
11	NUMERIC 00	80	MACRO4	149	PAGE DOWN
12	NUMERIC 000	81	MACRO5	150	PAGE UP
13	ADD CHECK	82	MACRO6	151	PAID OUT1
14	BACK SPACE	83	MACRO7	152	PAID OUT2
15	BOLD	84	MACRO8	153	PAID OUT2
16	CANCEL	85	MACRO9	154	PAID OUT4
17	CAPS	86	MACRO10	155	PAID OUT5
18	CASH	87	MACRO11	156	PAID RECALL
19	TIP DECLARE	88	MACRO12	157	% 1
20	SLIP	89	MACRO13	158	% 2
21	CHEQUE	90	MACRO14	159	% 3
22	CHEQUE CASH	91	MACRO15	160	% 4
23	CHK ENDORSE	92	MACRO16	161	% 5
24	CLEAR	93	MACRO17	162	% 6
25	CONTINUE	94	MACRO18	163	% 7
26	CURR.CONV 1 EURO	95	MACRO19	164	% 8
27	CURR.CONV 2	96	MACRO20	165	% 9
28	CURR.CONV 3	97	MACRO21	166	% 10
29	CURR.CONV 4	98	MACRO22	167	PLU
30	CURR.CONV 5	99	MACRO23	168	PREV.RECORD
31	CUR DOWN	100	MACRO24	169	PRICE INQ
32	CUR LEFT	101	MACRO25	170	PRICE LVL1

FUNCTION KEY – LISTING

33	CUR RIGHT	102	MACRO26	171	PRICE LVL2
34	CUR UP	103	MACRO27	172	PRICE LVL3
35	DECIMAL	104	MACRO28	173	PRICE LVL4
36	DELETE	105	MACRO29	174	PRICE LVL5
37	DONE	106	MACRO30	175	PRICE LVL6
38	ANALYSIS3	107	MACRO31	176	PRICE LVL7
39	ANALYSIS1	108	MACRO32	177	PRICE LVL8
40	EMPLOYEE	109	MACRO33	178	PRICE LVL9
41	EMPLOYEE1	110	MACRO34	179	PRICE LVL10
42	EMPLOYEE2	111	MACRO35	180	PRICE LVL11
43	EMPLOYEE3	112	MACRO36	181	PRICE LVL12
44	EMPLOYEE4	113	MACRO37	182	PRICE LVL13
45	EMPLOYEE5	114	MACRO38	183	PRICE LVL14
46	EMPLOYEE6	115	MACRO39	184	PRICE LVL15
47	EMPLOYEE7	116	MACRO40	185	PRICE LVL16
48	EMPLOYEE8	117	MACRO # (CODE NO.)	186	PRICE LVL17
49	EMPLOYEE9	118	MDSE RETURN	187	PRICE LVL18
50	EMPLOYEE10	119	MISC TEND1	188	PRICE LVL19
51	ENTER	120	MISC TEND2	189	PRICE LVL20
52	ERR.CORR.	121	MISC TEND3	190	PRINT
53	FD/S SHIFT	122	MISC TEND4	191	PRINT CHECK
54	FD/S SUBTL	123	MISC TEND5	192	PRINT HOLD
55	FD/S TEND	124	MISC TEND6	193	PROMO
56	GUEST #	125	MISC TEND7	194	PRT SCREEN
57	HOLD	126	MISC TEND8	195	QUIT
58	INACTIVE	127	MISC TEND9	196	RCPT ON/OFF
59	KEYBD LVL1	128	MISC TEND10	197	RECALL CHK1
60	KEYBD LVL2	129	MISC TEND11	198	RECALL CHK2
61	KEYBD LVL3	130	MISC TEND12	199	RECALL CHK3
62	KEYBD LVL4	131	MISC TEND13	200	RECALL CHK4
63	KEYBD LVL5	132	MISC TEND14	201	RECD ACCT1
64	LIST CHECK1	133	MISC TEND15	202	RECD ACCT2
65	LIST CHECK2	134	MISC TEND16	203	RECD ACCT3
66	LIST CHECK3	135	MISC TEND#	204	RECD ACCT4

FUNCTION KEY – LISTING

67	LIST CHECK4	136	MODIFIER1	205	RECD ACCT5
68	MACRO OFF	137	MODIFIER2	206	RECEIPT
69	MACRO P	138	MODIFIER3	207	REPEAT
208	SCALE	231	TIME IN/OUT (CLOCK IN/OUT)	254	NOFOUND PLU
209	SEAT #	232	TIP1	255	PRICE CHG
210	SHIFT	233	TIP2		
211	SPLIT ITEM	234	TIP3		
212	SPLIT PAY	235	TRANS CHK1		
213	STOCK INQ	236	TRANS CHK2		
214	STORE CHK1	237	TRANS CHK3		
215	STORE CHK2	238	TRANS CHK4		
216	STORE CHK3	239	TRAY SUBTL (TICKET ISSUE)		
217	STORE CHK4	240	VALID		
218	SUBTOTAL	241	VOID ITEM		
219	TABLE 1	242	WASTE		
220	TABLE 2	243	WLU		
221	TABLE 3	244	X/TIME		
222	TABLE 4	245	YES/NO		
223	ANALYSIS2	246	PARK ORDER		
224	TAX EXEMPT	247	SERVE ORDER		
225	TAX SHIFT1	248	KP ROUTING		
226	TAX SHIFT2	249	SPLIT CHECK		
227	TAX SHIFT3	250	NEW CHECK1		
228	TAX SHIFT4	251	NEW CHECK2		
229	TAX SHIFT5	252	NEW CHECK3		
230	TAX SHIFT6	253	NEW CHECK4		

FUNCTION KEY - DEFINITIONS

NUMERIC 1

Used to reposition the numeric keypad anywhere on the keyboard

NUMERIC 2

Used to reposition the numeric keypad anywhere on the keyboard

NUMERIC 3

Used to reposition the numeric keypad anywhere on the keyboard

NUMERIC 4

Used to reposition the numeric keypad anywhere on the keyboard

NUMERIC 5

Used to reposition the numeric keypad anywhere on the keyboard

NUMERIC 6

Used to reposition the numeric keypad anywhere on the keyboard

NUMERIC 7

Used to reposition the numeric keypad anywhere on the keyboard

NUMERIC 8

Used to reposition the numeric keypad anywhere on the keyboard

NUMERIC 9

Used to reposition the numeric keypad anywhere on the keyboard

NUMERIC 00

Used to reposition the numeric keypad anywhere on the keyboard

NUMERIC 000

Used to reposition the numeric keypad anywhere on the keyboard

ADD CHECK

Used to add multiple guest checks (soft checks) for payment together or to add check between different tracking files, or to move one check to another.

ACTIVE IN X ONLY

This forces the use of X Manager Mode for this key

FUNCTION KEY - DEFINITIONS

BACK SPACE

Used to program the alpha BACKSPACE function key

CANCEL

Press the cancel to abort a transaction in progress. All current items are removed (voided)

HALO (0:NO LIMIT)

This is the maximum sale amount for this key

ACTIVE IN X ONLY

This forces the use of X Manager Mode for this key

COMPULSORY VALIDATION

This forces validation if a cancel is carried out (only on printer models with a validation option)

PRINT RECEIPT

This controls whether cancelled transactions will be printed.

CAPS

Used to program the alpha programming CAPTIAL Letters lock function key

CASH

Used to finalise or tender cash sales. Change is computed when the amount of the cash tender is greater than the amount of the sale. The optional system flag can be set allow change calculation on a sales is finalised using the post tender system flag

HALO (0:NO LIMIT)

This is the maximum sale amount for this key

EXEMPT TAX

This allows each tax rate to be excluded from the sale calculation

OPEN DRAWER

This controls whether the cash drawer will open.

COMPULSORY VALIDATION

This forces validation if a cancel is carried out (only on printer models with a validation option)

AMOUNT TENDER COMPULSORY

This forces the entry of moneys given for change

DISABLE UNDER TENDERING

This prohibits partial tender i.e. Value lower than sale

ALLOW UNDER TENDER IN X ONLY

This forces use of X Manager mode for partial tender

COIN CHANGE PORT# (0-7)

Mainly for the US market this allows an automated coin changer

TIP DECLARE

This is used for the declaration of tips earned by employees

ACTIVE IN X ONLY

This forces the use of X Manager Mode for this key

COMPULSORY VALIDATION

This forces validation if a cancel is carried out (only on printer models with a validation option)

SLIP

Used to print guest check bills to a loose-leaf paper printer

PRINT CHECK ON PRINTER# (0 – 40)

This determines which printer from the systems printer list will be used for bills

PRINT CHECK AUTOMATICALLY

This will automatically close the check after printing

SERVICE CHECK

PRINT CONSEC# ON GUEST CHECK

This will determine if the receipt consecutive number is printed on the bill

FUNCTION KEY - DEFINITIONS

CHEQUE

Use this key to finalise or tender cheque sales. Change is computed when the amount of the cheque tender is greater than the amount of the sale, for cash back etc...

HALO (0:NO LIMIT)	This is the maximum sale amount for this key
EXEMPT TAX	This allows each tax rate to be excluded from the sale calculation
OPEN DRAWER	This controls whether the cash drawer will open.
COMPULSORY VALIDATION	This forces validation if a cancel is carried out (only on printer models with a validation option)
COMPULSORY CHEQUE ENDORSE	This forces endorsement printing onto a check (only on printer models with a validation option)
AMOUNT TENDER COMPULSORY	This forces the entry of moneys given for change
DISABLE UNDER TENDERING	This prohibits partial tender i.e. Value lower than sale
ALLOW UNDER TENDER IN X ONLY	This forces use of X Manager mode for partial tender
NON-ADD# ENTRY COMPULSORY	This forces the operator to enter a reference number
HALO : Y=CHANGE/N=TENDER	The maximum value can apply either to the sale amount tendered or to the change given
COIN CHANGE PORT# (0-7)	Mainly for the US market this allows an automated coin changer

CHEQUE CASHING

Use the Cheque Cashing key to exchange a cheque for cash outside of a sale.

HALO (0:NO LIMIT)	This is the maximum sale amount for this key
ACTIVE IN X ONLY	This forces the use of X Manager Mode for this key
ALLOW HALO OVERRIDE IN X ONLY	This forces the use of X Manager mode to override the maximum value
COMPULSORY VALIDATION	This forces validation if a cancel is carried out (only on printer models with a validation option)

CHK ENDORSEMENT

This will print onto the check an endorsement message (only on printer models with a validation sensor)

PRINTING PORT# (0 -7)	This is the physical port that the printer is connected
------------------------------	---

CLEAR

Press CLEAR to clear numeric entries or error conditions

CONTINUE

Used in-conjunction with the magnetic card swipe system

FUNCTION KEY - DEFINITIONS

CURR.CONV 1 - 5

Used to convert and display the value of the transaction in foreign currency. This works also for Euro dual totalling in-conjunction with system printing flags. It is assumed currency rate one is the Euro rate

RATE	This is the current exchange rate
CHANGE IN FOREIGN CURRENCY	This determines whether change is given in the local currency or in the same currency by as the sale was paid.
LINKED DRAWER # (0 - 3)	This is the cash drawer, which is to be opened

CURSOR DOWN

Use the cursor control keys to program the position of the cursor on the screen

CURSOR UP

Use the cursor control keys to program the position of the cursor on the screen

CURSOR LEFT

Use the cursor control keys to program the position of the cursor on the screen

CURSOR RIGHT

Use the cursor control keys to program the position of the cursor on the screen

DECIMAL

Use the decimal key to enter fractional rates or percentages. Do not use to enter amounts.

DELETE

Used to program the alpha programming DELETE function key.

DONE

Press DONE to exit a WLU screen when multiple entries are allowed on the WLU. This key is a required program can and should not be omitted from the keyboard. This key also acts as a backspace when programming alpha

ANALYSIS 3

This key is used to record sales totals providing analysis on the both the financial report and special hourly sales analysis report. The default text can be changed providing sales analysis for any category. This key can also be programmed to switch the printing area of kitchen orders.

EXEMPT TAX	This allows each tax rate to be excluded from the calculation
COMPULSORY VALIDATION	This forces validation if a cancel is carried out (only on printers with validation)
KP PERIOD OVERRIDE	This changes the area in which the item is printed from the normal programmed route to one of the 4 pre-programmed kitchen printer periods

FUNCTION KEY - DEFINITIONS

ANALYSIS 1

This key is used to record sales totals providing analysis on the both the financial report and special hourly sales analysis report. The default text can be changed providing sales analysis for any category. This key can also be programmed to switch the printing area of kitchen orders.

EXEMPT TAX	This allows each tax rate to be excluded from the sale calculation
COMPULSORY VALIDATION	This forces validation if a cancel is carried out (only on printers with validation)
KP PERIOD OVERRIDE	This changes the area in which the item is printed from the normal programmed route to one of the 4 pre-programmed printer periods

EMPLOYEE # (CASHIER)

The employee number key is used to sign on a cashier, clerk, server or employee who is starting registration. This is used for CLERK CODE entry.

EMPLOYEE 1 - 10

The employee key can be programmed to sign on a specific cashier when pressed directly without entering a code, the employee 1 - 10 keys can be used for this purpose. These keys are used for PUSH Button clerk entry. The employee number to be allocated to this key is set in P-Mode, system options programming

ERR CORRECT

Press error correct immediately after an item to remove that item from the sale total. This key also acts as a delete key when programming items to a Window Look Up.

HALO (0:NO LIMIT)	This is the maximum sale amount for this key
ACTIVE IN X ONLY	This forces the use of X Manager Mode for this key
COMPULSORY VALIDATION	This forces validation if a cancel is carried out (only valid printers)

FD STAMP SHIFT

Press FD STAMP SHIFT to shift the pre-programmed food voucher status of an item prior to its sale

FD STAMP SUBTL

Press FD STMP SUBTTL to display the total of food stamp voucher eligible items in the current sale

FD STAMP TENDER

Use the FD STMP TENDER key to tender Food Stamp vouchers after the display of the food stamp eligible subtotal. Depending upon function key programming, change less than £1 can be applied to any cash balance or issued as cash change.

HALO (0:NO LIMIT)	This is the maximum sale amount for this key
EXEMPT TAX	This allows each tax rate to be excluded from the calculation
OPEN DRAWER	This is the cash drawer, which is to be opened
ALLOW DECIMAL ENTRY	This allows decimal as well as integer values
FOOD STAMP CHANGE: Y=CASH/N=FOOD STAMP	Change can be given either in cash or in stamps

FUNCTION KEY - DEFINITIONS

GUEST

Used to record the number of guests served by a transaction. The entry may be compulsory, the entry can also be programmed to appear on printers

COMP AFTER BEGINNING OF CHECK This forces guest entry when a check is opened
COMPULSORY FOR ALL SALES This forces guest entry at all times
PRINT ON KP (Kitchen Printer) This prints the number of guests on kitchen order

HOLD

Used to identify an individual item, or an entire transaction, in order that the selected items will not print/display on the kitchen printer / KVS when the transaction is finalised. The system can be programmed to warn if items are held when a check is stored, also to automatic select ready print when a check is recalled.

ACTIVE IN X ONLY This forces the use of X Manager Mode for this key

INACTIVE

The inactive function key can be re-used as many times as necessary to inactivate key locations

KEYBOARD LEVEL 1 - 5

Use to select one of the five keyboard levels, Menu levels can be automatically changed at specific times, on specific days.

ACTIVE IN X ONLY This forces the use of X Manager Mode for this key

LIST CHECK 1 - 4

Press the List Check key to display a list of open checks.

ACTIVE IN X ONLY This forces the use of X Manager Mode for this key

MACRO OFF

This switches the macro during the pre-programmed key sequence to the Off-mode position. This key is not required on the keyboard as it is used only during macro programming

MACRO P

This switches the macro during the pre-programmed key sequence to the P-mode position. This key is not required on the keyboard as it is used only during macro programming

MACRO PAUSE

Used to indicate a pause in the macro, allowing greater user choice for the display and operation of macros one pause per required key press is programmed.

MACRO R

This switches the macro during the pre-programmed key sequence to the Register mode position. This key is not required on the keyboard an is used only during macro programming

FUNCTION KEY - DEFINITIONS

MACRO S

This switches the macro during the pre-programmed key sequence to the S-mode position. This key is not required on the keyboard as it is used only during macro programming

MACRO SET

This key is used in REG as a method of programming macros by recording the key strokes as they are entered. By pressing the MACRO SET key carrying out the require mode changes, key strokes etc then pressing the MACRO1-40 key to finalise the sequences to that key.

MACRO VOID

This switches the macro during the pre-programmed key sequence to the Void-mode position. This key is not required on the keyboard as it is used only during macro programming

MACRO X

This switches the macro during the pre-programmed key sequence to the X-mode position. This key is not required on the keyboard as it is used only during macro programming

MACRO Z

This switches the macro during the pre-programmed key sequence to the Z-mode position. This key is not required on the keyboard as it is used only during macro programming

MACRO 1 - 40

Used to execute one of the forty possible pre-programmed key sequences, by allocating the required key to the keyboard and then programming the appropriate sequence

ACTIVE IN X ONLY This forces the use of X Manager Mode for this key
The macro key sequence is also programmed here if it has not been programmed using a MACRO SET key

MACRO #

Used to execute one of forty possible macros by entering the macro number and pressing the macro code entry key macros can also be included within a WLU key list for menu selection of an option.

MDSE RETURN

Use to remove items from the sales totals within or outside of a transaction

HALO (0:NO LIMIT)	This is the maximum sale amount for this key
ACTIVE IN X ONLY	This forces the use of X Manager Mode for this key
COMPULSORY VALIDATION	This forces validation if a cancel is carried out (only on printer models with a validation option)
ADD TO NET GRAND TOTAL	This adds instead of subtracting to the grand totals
SKIP ADJUSTMENT OF PLU TOTAL	The key as standard subtracts the refunded items from the PLU totals this prevents that happening

FUNCTION KEY - DEFINITIONS

MISC TEND 1 - 16

Use a MISC TEND key to finalise or tender sales paid by various charges or other media. Tendering may or may not be allowed depending upon programming, over tendering is possible providing a credit card cash back feature.

HALO (0:NO LIMIT)	This is the maximum sale amount for this key
EXEMPT TAX	This allows each tax rate to be excluded from the sale calculation
OPEN DRAWER	This controls whether the cash drawer will open.
COMPULSORY VALIDATION	This forces validation if a cancel is carried out (only on printer models with a validation option)
AMOUNT TENDER COMPULSORY	This forces the entry of moneys given for change
DISABLE UNDER TENDERING	This prohibits partial tender i.e. Value below sale
ALLOW UNDER TENDER IN X ONLY	This forces the X Manager mode for partial tendering
NON-ADD# ENTRY COMPULSORY	This forces the operator to enter a reference number
ALLOW OVER TENDER	This allows an amount greater than the sales total To be tendered. This can be used to given change or for the cash back feature
COIN CHANGE PORT# (0-7)	Mainly for the US market this allows an automated coin changer
CONNECT EFT TERMINAL	This allows connection of an authorised Electronic Fund transfer terminal (credit card terminal)
EFT TRANSACTION KEY (0-9)	This is the function key used for download of EFT TRANSACTION KEY 1= CHEQ 2=CARD

MISC TEND

Used to access by code any one of the 16 MISC TEND keys used to finalise or tender sales paid by various charges or other media. Tendering may or may not be allowed depending upon programming

MODIFIER 1 - 10

Preceding a PLU entry a modifier key changes one digit of the PLU number, causing a different PLU to be registered. MODIFIER Keys can be set to change either the item code or the description only. This can be used to be build up a code number system with various modifiers working together to sell a complied code. For example if MODIFIER 1 is set to change the 4th digit of the PLU by 4 and MODIFIER 2 is set to change the 3rd digit by 5 pressing MODIFIER 1 then MODIFIER 2 followed by PLU 1 would sell code 4501 PLU 2 would become 4502 etc.. There are relevant system options which can be change to control how modifier keys operate.

ACTIVE IN X ONLY	This forces the use of X Manager Mode for this key
MODIFY DESCRIPTOR ONLY	This changes the description of the product but not the code
PRINT DESCRIPTOR ON GUEST CHECK	The modifier key description is prevented from being printed on a check tracking bill
PRINT DESCRIPTOR ON RECEIPT	The modifier key description is prevented from being printed on the customer transaction receipt.
AFFECT DIGIT 1-18 OF PLU#	The digits of the PLU code can be modified by the next field
VALUE OF AFFECTED DIGIT (0 - 9) OF PLU	This is the number 0-9 by which the selected digit is to be Changed i.e. 3 affected by value 2 means 1 = 201, 2 = 202

FUNCTION KEY - DEFINITIONS

NEXT RECORD

Used to program the next record key, used during programming to move through the program records.

#/NOSALE

Used to enter a non-adding memo number during a transaction, or used to open the cash drawer outside of a sale

HALO DIGITS FOR NON-ADD ENTRY	This is the maximum digits for the reference number.
ALLOW NOSALE FUNCTION	This will enable the operator to open the cash drawer
ALLOW NON-ADD FUNCTION	This will enable the operator to enter a reference number
NOSALE IN X ONLY	This forces the use of X Manager Mode for this key
NOSALE INACTIVE AFTER NON-ADD ENTRY	Once a reference has been entered it its not possible to continue by just opening the drawer, a sale is required.
COMPULSORY VALID ON NOSALE	This forces validation if a cancel is done (only on valid printers)
ENFORCE NON-ADD AT BEGINNING OF SALE	This forces the operator to enter a reference number before commencing a sale
COMP. NON-ADD# MUST MATCH HALO DIGIT#	The halo is no longer a maximum but a compulsory criteria i.e. 6 becomes not digit 1 to 6 but fixed to 6 digits

P/BAL

Enter an amount, then press the manual previous balance (P/bal) key to use the simplest form of charge posting / Table Service. The P/bal key may be used any time, within a transaction. Transactions where the P/Bal key is used must be finalised with the service key

MUST BE ENTERED AT START OF SALE	This forces an opening balance at start of a sale
COMPULSORY P/BAL	This forces an entry of balance during a sale.

PAGE DOWN

This key switches between pages on the register display. Used in Window Look Ups etc.

PAGE UP

This key switches between pages on the register display. Used in Window Look Ups etc.

PAID OUT 1 - 5

Press a Paid Out key to remove moneys from the drawer

HALO (0:NO LIMIT)	This is the maximum sale amount for this key
ACTIVE IN X ONLY	This forces the use of X Manager Mode for this key
COMPULSORY VALIDATION	This forces validation on this key (only on valid printers)

PAID RECALL

The paid recall key is used to recall the last number of transactions, where the number of transaction is determined in the memory allocation. The RECEIPT key can be used to issue copy receipt of past transactions.

ACTIVE IN X ONLY	This forces the use of X Manager Mode for this key
-------------------------	--

FUNCTION KEY - DEFINITIONS

%1 - %10

Ten discount/Premium keys are available to handle various types of discounts, mark-downs and adjustments to items or transactions.

HALO / RATE

For open keys this is the maximum amount, for fixed percent items It is the rate to be applied

TAXABLE by RATE 1 - 6 FUNCTION IS INACTIVE

The discount/premium amount can be included within the tax This allows the items to be prohibited without the necessity to make the key inactive

FUNCTION IS ACTIVE IN X ONLY FUNCTION IS SALE / ITEM

This forces use of the X Manager Mode for operation This determines whether the function must be applied to each item or to the whole sale total after subtotal.

FUNCTION IS AMOUNT / PERCENT

This determines whether the function will apply either a monetary or a percent adjustment.

FUNCTION IS PLUS / MINUS

This determines whether the adjustment will be applied as either a discount or addition.

FUNCTION IS OPEN / PRESET COMPULSORY VALIDATION ALLOW PRESET OVERRIDE

This determines the adjustment i.e. pre-set rate or manual This forces validation (only on valid printers) This enables the operator to manually enter an adjustment even when there is a pre-programmed rate

PRESET OVERRIDE IN X ONLY

This forces use of the X Manager Mode when it is necessary override the pre-programmed amount.

FUNCTION NETS ITEM TOTAL

This reports the values inclusive of the adjustment I.e. 1.00 – 10% would report 90p

FUNCTION IS FOOD STAMP ELIGIBLE

This is for the US Market it ensures the discount is considered when selling food stamp products.

ALLOW MULTIPLE SALE COUPONS ALLOW ONLY ONE DISCOUNT PER TRANS

This enables more than one coupon operation per sale. This restricts the operation of discount /premium added at subtotal

KEY IS “DO IT” DISCOUNT FUNCTION

This operates a sale rounding system not used within the UK. For example If a Sale if made for 7.20 and DO IT FUNCTION set The sale value will be taken as 7.00 – the % cutting off the 0.20

PLU

Used to sell an item using the products code number rather than pressing a PLU key on the keyboard.

PREVIOUS RECORD

Used to reposition the previous record key, which is used during programming to move through the program records.

PRICE INQUIRE

Used to inquire on the retail price of a product this can be for single item or multiple products

ACTIVE IN X ONLY

This forces the use of X Manager Mode for this key

STAY DOWN/POP UP

Price inquiry for Single item or for multiple items

FUNCTION KEY - DEFINITIONS

PRICE LEVEL 1 - 20

Press a price level key prior to a PLU entry to shift the price of a PLU to a different 'price set' pre-programmed to the PLU. Each product has the ability to sell at five different prices. The prices are not fixed however at price levels 1 through to five. The Price level can be allocated from any of the twenty to provide detailed price reporting using the PLU by price level report (if set in memory allocation). The norm for a bar is two prices normal and special offer price this requires no special programming. The terminal however can be programmed to used up to twenty price bands. For example we could have some PLUs using prices 1 – 5 representing sizes and some PLUs using prices 6 – 10. This would then representing different products types sold at different sizes; pressing the appropriate price key will sell the correct size. Then using the price level report, the analysis would show the total per product a breakdown of the price sales per product and an overall sales total for all products per price level

ACTIVE IN X ONLY

This forces the use of X Manager Mode for this key

PRINT

This key is used to temporarily change the remote printer settings of a PLU allowing printing to the programmed printer route. This key is required on the keyboard if the PLU auto grill feature is to be used.

OUTPUT PRINTER # (0-40)

This is the printer number to which the items are printed.

PRINT CHECK

Used to print a bill for any of the check tracking files 1 - 4

PRINT CHECK ON PRINTER # (0-40) This is the printer number which will print the check bill.

PRINT CHECK AUTOMATICALLY This will ensure no manual operation of the print check key is required. The check is held after the bill is printed.

SERVICE CHECK

PRINT CONSEC# ON GUEST CHECK This enables the receipt number to be printed on bill

PRINT HOLD

Used to remove the HOLD designation from an item or order, so that the items and their instructions are sent to the kitchen printer/KVS at finalisation, check hold

ACTIVE IN X ONLY

This forces the use of X Manager Mode for this key

PROMO

Press the PROMO key to void the price (the item remains). This can be used in 2 for 1 promotions. A promo count is available for each item

ACTIVE IN X ONLY

This forces the use of X Manager Mode for this key

TAXABLE by RATE 1 - 6

The amount can be included within the tax calculation, relevant if VAT is to be added, to prevent the from being required as a payment.

PRINT SCREEN

Press the print screen key to print a copy of the current screen on the designated receipt printer

QUIT

Press QUIT to automatically sign on/off the current cashier/clerk, using the magnetic card swipe reader.

FUNCTION KEY - DEFINITIONS

RECEIPT ON /OFF

This is used to turn the receipt off, The receipt can be programmed using system flags to be a continuous receipt with post receipt, or to print only when the post receipt key is pressed.

RECALL CHECK 1 - 4

The Check Tracking System can maintain only balances (hard checks) or entire transactions (soft checks) in the registers memory. Four different tracking files can be separated to maintain different information for example, restaurant checks, call-in orders, delivery orders, and or table balances. The check number can be entered by the operator or calculated automatically by the system

ACTIVE IN X ONLY
ENFORCE SEAT#

This forces the use of X Manager Mode for this key
This makes it compulsory to enter the seat of each person at the table so that if required at finalisation seat separation and split payment can be carried out.

TABLE ENTRY REQUIRED
MULTIPLE CHECKS ALLOWED
FOR EACH TABLE
GUEST COUNT ENTRY REQUIRED
COMPULSORY FOR ALL SALES
ASSIGNED BY REGISTER

This force the operator to enter a table number
The table number can also be used to recall open checks.
Allows the user to have more than one check at each table.
This requests the input of guests when a check is opened
This forces the operator to enter a check for every sale
The system can work on manually entered check number, or can generate it's own sequential number

OPENING EMPLOYEE HAS
EXCLUSIVE ACCESS
PRINT CHECK# ON RECEIPT
PRINT CHECK# ON JOURNAL
PRINT CHECK# ON KP
AUTO CHECK MANAGEMENT

The check can be restricted in operation solely to the employee that started the sale.
This allows the check number from printing on the receipt
This allows the check number from printing on the audit
This allows the check number from printing on the order
The sale is made and stored and the check number is automatically generated, pressing the check key recalls the oldest check ready for finalisation. This can be overwritten by manually entering the check

PRINT ON CHECK AUTOMATICALLY
DISABLE OPEN A NEW CHECK

The sale details can be printed automatically when stored
This forces use of the New Check key for sales to a check that does Not already exist. (the New Check key follows the status of the this key)

LENGTH OF CHECK# IN DIGITS(0 -10)The check can have an enforced number of digits.

RECD ACCT 1 - 5

Press a RECD ACCT key to add cash, check or miscellaneous media to the drawer

HALO (0:NO LIMIT)
ACTIVE IN X ONLY
COMPULSORY VALIDATION

This is the maximum sale amount for this key
This forces the use of X Manager Mode for this key
This forces validation if a cancel is done (only on valid printers)

RECEIPT

Press this key to issue a transaction receipt at the designated receipt printer

FUNCTION KEY - DEFINITIONS

REPEAT

Use the repeat key to quickly re-order a set of items. When a check is recalled

ACTIVE IN X ONLY This forces the use of X Manager Mode for this key

SCALE

Use the scale key r to manually enter a weight for extension.

ACTIVE IN X ONLY This forces the use of X Manager Mode for this key

ALLOW MANUAL ENTRY OF WEIGHT Weight can either be entered manually or on a scale

INHIBIT TARE WEIGHT ENTRY

The system will allow the tare weight management

TARE ENTRY IN X ONLY

This force the use of X Manager mode for this operation

TARE ENTRY IS COMPULSORY

This forces the operator to use the tare weight method.

WEIGHT SYMBOL

This allows for either pounds or kilo entry.

SET TARE WEIGHT

This access a sub menu for tare weight programming

SEAT#

Used to identify a specific seat (or person) within a transaction. Facilitates separate payment by seat from a single check and identifies to the food preparation staff (through KPs and KVs) how to assemble meals.

ACTIVE IN X ONLY This forces the use of X Manager Mode for this key

SHIFT

Used to program the alpha programming Shift capital Letters lock function key

SPLIT ITEM

When like items are consolidated in a transaction. You can move the cursor to the item and press the SPLIT ITEM key to display the items separately, instead of in consolidated form. Used in-conjunction with the SEAT key

ACTIVE IN X ONLY This forces the use of X Manager Mode for this key

SPLIT PAYMENT

Use the split payment key to divide the amount of a guest check into equal segments for payment and issue bills accordingly. To pay bills using the split payment method, recall the guest check press the subtotal key then enter the numer of people by which the bill is to be split then press the split payment key to activate the display of balances due for payment for each person.

ACTIVE IN X ONLY This forces the use of X Manager Mode for this key

STOCK INQUIRY

Used to display the current stock situation for a PLU, this will display the total for all the registers

ACTIVE IN X ONLY This forces the use of X Manager Mode for this key

Y=STAY DOWN/N=POP UP If set to stay down the terminal will stay in price inquire mode

FUNCTION KEY - DEFINITIONS

STORE CHECK 1 - 4

The check tracking system can maintain only balances (hard check) or entire transactions (soft check) in the register memory. Four different tracking files can be separately maintained. For example, restaurant checks, call-in orders, delivery orders, and/or table balance. Press one of the four STORE CHECK # keys to finalise a tracking transaction

HALO (0:NO LIMIT)

For open keys this is the maximum amount, for fixed percent items It is the rate to be applied

EXEMPT TAX

This allows each tax rate to be excluded from the sale calculation

ACTIVE IN X ONLY

This forces the use of X Manager Mode for this key

COMPULSORY VALIDATION

This forces validation if a cancel is carried out (only on a printer with a validation sensor)

NON-ADD# COMPULSORY

This forces the entry of a reference number using #/Nosale

PRINT ON RECEIPT

This allows the function description printing

PRINT ON JOURNAL

This allows the function description printing

SERVICE OF NEGATIVE

This forces the operator to use the X manager mode storage of checks, which have a minus sale total.

BALANCE IN X ONLY

HARD CHECK PRINTER # (0 - 40)

This is printer number which the check will print to when using this key for balance on tracking, when NON detailed / Hard check tracking is used, the print check key will print the detailed bill.

AUTO CHECK MANAGEMENT

This allows store of a sale onto a sequential check number without having to initially open the check.

SUBTOTAL

Used to display the balance due.

TABLE 1 - 4

This is used for reference as to which table a check is related to, there can be numerous checks per table, depending upon, the programming of the store check key. Checks can also be recalled using the table number.

ANALYSIS 2

This key is used to record sales totals providing analysis on the both the financial report and special hourly sales analysis report. The default text can be changed providing sales analysis for any category. This key can also be programmed to switch the printing area of kitchen orders.

EXEMPT TAX

This allows each tax rate to be excluded from the sale calculation

COMPULSORY VALIDATION

This forces validation if a cancel is carried out (only on printers with validation)

KP PERIOD OVERRIDE

This changes the area in which the item is printed from the normal programmed route to one of the 4 pre-programmed printer periods

FUNCTION KEY - DEFINITIONS

TAX EXEMPT

The Tax Exempt can be programmed to exempt specific taxes from a sale.

HALO (0:NO LIMIT)

This is the maximum sale amount for this key

EXEMPT TAX

Each Tax rate can be excluded for the calculation

NON-ADD# COMPULSORY

This forces the entry of a reference number using the #/no sale

COMPULSORY VALIDATION

This forces validation if a cancel is carried out (only on printer models with a validation option)

TAX SHIFT 1 - 6

These are used to change temporarily the pre-programmed tax rate of a product.

TIME IN/OUT (CLOCK IN/OUT)

Enter the employee clock in code then press the key to record start and end work times, breaks etc. Hours are maintained by the time clock system. There are various analysis reports for labour costing analysis to assist with management of this feature.

ACTIVE IN X ONLY

This forces the use of X Manager Mode for this key

COMPULSORY VALIDATION

This forces validation if a cancel is entered (only on printer on printer if a cancel is carried out)

TIP 1 - 3

Used to enter a tip amount on a check tracking bill

HALO (0:NO LIMIT)

This is the maximum sale amount for this key

TIP : Y=PERCENTAGE / N=AMOUNT

This determines whether the value entered is to be applied as a monetary amount or a percentage

TAXABLE by RATE 1 - 6

The can be included within the tax calculation

MUST BE PAID BY MISC TEND

This forces finalisation on a miscellaneous tender key once a tip entry has been made.

AFTER TIP

TIP AMOUNTS ADD TO

The tip amount can be added into financial totals, this includes the moneys in the sales totals.

NET & GROSS TOTALS

CHARGE TIP IS DEDUCTED

The tip can be applied as a cash financial total, the value is then subtracted from the cash totalisers.

FROM CASH

TRAY SUBTOTAL (TICKET ISSUANCE)

This key provides excellent flexibility of receipt issuance, it can be used, admission tickets, The sale is entered as normal in register when a receipt is required this key is pressed and a receipt for all items sold to that point is issued. The sale is continued and again this key is pressed issued a receipt for all items sold in the 2nd part of the sale a final payment receipt can then be issued at finalisation

EXEMPT TAX

Each Tax rate can be excluded for the calculation

ACTIVE IN X ONLY

This forces the use of X Manager Mode for this key

COMPULSORY BEFORE TENDER

This forces use of this key to display total sale value

COMPULSORY VALIDATION

This forces validation if a cancel is done (only on valid printers)

ADVANCE CONSEC# AT FINAL

Each receipt issued can have a consecutive number or each can have the same number.

TENDER ONLY

FUNCTION KEY - DEFINITIONS

TRANSFER CHECK 1 - 4

Used to transfer one or all open soft checks from one server to another. A transfer check receipt will print.

ACTIVE IN X ONLY

This forces the use of X Manager Mode for this key

VALIDATE

Use this key to initiate a single line validation (a printer with validation capability is required in the system)

WASTE

Used to start and end entries of items that are wasted. A waste count is maintained for each item and the inventory is adjusted.

ACTIVE IN X ONLY

This forces the use of X Manager Mode for this key

COMPULSORY VALIDATION

This forces validation if a cancel is carried out (only on printer models with a validation option)

AFFECT ON PROJECTIONS

Are the wastage values to be included in the product mix group usage.

WLU

Used to access window look up menus by their code number or to allocate a WLU one touch button to the keyboard

X/TIME

Used for multiplication and split pricing

ALLOW SPLIT PRICING

This allows entry of fraction quantities i.e. 1 x/time3 x/time - will result in a 3rd of the items quantity and value being sold i.e. 1.00 sold @ 1/3 is 33.333

YES/NO

Used to answer programming and operation questions

NEW CHECK 1 – 4

The standard recall check key, allows a check to be opened if it does not already exist. This is excellent in hospitality tracking, however for account management credit may not so readily be given. When this button is programmed accounts are not opened automatically. A warning will indicate an account does not exist if an attempt is made to open using the recall check The new check button is used to open any new accounts. The programmability for this key is automatically picked up from the status of the Recall check key.

NOFOUND PLU (NOT FOUND PLU)

If a code is entered or scanned that does not exist It is then possible using this key to create that item.

PRICE CHANGE

This allows the price of an item to be changed. This can have prohibited or restricted allocated to the PLU.

SYSTEM OPTIONS

Options are sorted by category to assist the programmer in finding a specific option.

P-MODE PROGRAMMING MENU	L1
1. PLU	
2. PLU STATUS GROUP	
3. GROUP	
4. FUNCTION KEY	
5. SYSTEM OPTION	
6. TAXES	
7. MESSAGES	
8. WINDOW LOOK UP (WLU)	
9. TIME PERIOD	
10. EMPLOYEE	
11. AUTHORITY LEVEL	
12. PRINTER TABLES & KV ROUTING	
▼	ENTER PAGE UP/DN ↑↓

SYSTEM OPTION PROGRAMMING	L1
1. GENERAL FUNCTION OPTIONS	
2. TAX OPTIONS	
3. CASH DRAWER OPTIONS	
4. TRAINING MODE OPTIONS	
5. LEVEL/MODIFIER OPTIONS	
6. TRACKING FILE OPTIONS	
7. KITCHEN PRINTING/VIDEO OPTIONS	
8. VALIDATION /SUBTOTAL PRT OPTIONS	
9. GENERAL PRINTING OPTIONS	
10. REPORT PRINTING OPTIONS	
11. REPORT OPTIONS	
12. TIME KEEPING OPTIONS	
▼	ESC ENTER PAGE UP/DN ↑↓

SYSTEM OPTION – DEFINITIONS

GENERAL FUNCTION OPTIONS

MANAGER CONTROL IN X-MODE

Negative Sales

This prevents minus priced products being sold in the register position. Manager access of the X mode is required to continue the sale.

Negative Tender

This prevents transaction which are a minus value being finalised in the register position. Manager access of the X mode is required to finalise the sale.

Zero Sales

This prevents zero priced products being sold in the register position. Manager access of the X mode is required to continue the sale.

ENFORCE ANALYSIS 1,2,3:

At Begin of Sale.

This makes it compulsory to press one of the three totalisers keys at the beginning of a sale. When using the analysis keys to compulsory change the printing to kitchen periods the analysis key would be forced at the beginning of the sale

Before Tender

This makes it compulsory to press one of the three totalisers keys at the end of a sale.

DEFAULT DESTINATION

This enables the most common of the three types of sales totalisers to be set as standard. It is possible to press either of the two alternative keys to switch the sales totals to another area.

ROUNDING ON %

It is assumed as standard when a minus/premium calculation is carried out rounding with round up/off at the 3rd decimal place. This can be changed to round either down or off at the 3rd decimal.

ROUNDING ON SPLIT PRICE / DECIMAL MULTIPLICATION.

This allows entry of fraction quantities i.e. 1 @/for 3 @/for - will result in a 3rd of the items quantity and value being sold i.e. 1.00 sold @ 1/3 is 33.333 It is assumed round up/off at the 3rd decimal place. This can be changed to round either down or off at the 3rd decimal.

CONSOLIDATE LIKE ITEMS

This combines items together i.e. 2 of PLU 1 would print PLU1, PLU 1 with this flag set it is 2 x PLU1

HASH OPTIONS

When a product is set as HASH this means all totalisers for this product are not to be treated in the normal manner, i.e. added to gross, net etc. The Hash PLU can be added to various totalisers

ACTIVATE ROUNDING ON CASH

Design for the European market used to activate total rounding

SYSTEM OPTION – DEFINITIONS

GENERAL FUNCTION OPTIONS

ACTIVATE ROUNDING ON SUBTOTAL

Design for the European market used to activate total rounding

GLOBAL ENTRY LIMIT

This forces the system to only accept the number of digits entered here i.e. 4 digit means only 99.99 can ever be made as a sale. However remember that if you require a maximum of 99.99 sale it would be better to Enter 5 digits as to tender would require 100.00

DIRECT MULTIPLICATION

Under normal circumstances a value which is entered then proceeded by a product is assumed to be a price entry. However with this flag on it is assumed to be a quantity this in turn eliminates the need for the x/time key. For example to sell 5 of product 1 you would not use 5 x/time product 1 but simple 5 product 1. This applies to preset items only.

Maximum Digit (1-5)

This is the maximum digits that can be entered for a quantity multiplication.

ALLOW PLU PRESET/HALO OVERRIDE

This when disabled prevents any product being sold as a manual price override of a pre-programmed price. This is a general setting, taking priority other program restrictions that may be in place for the products.

SILENT KEY DEPRESSION

This prevents the system for making a key beep when a button is pressed.

ALPHA CODE ENTRY

This determines whether characters entered on the system will be through character codes or using then pre-programmed alpha layout.

ALLOW OPEN ENTRY FOR SCALE PLUS

This determines whether scaleable PLUs are to enter weight automatically from a linked scale or using a manual entry of weight onto the SCALE key.

DEACTIVATE VOID MODE

This is a security feature to disallow completely the void mode on this terminal.

DISABLE DATE/TIME PROGRAMMING

This is a security feature to disallow the date and time change within the x mode. However if there are some requirements for this programming on the terminal the AUTHORITY PROGRAMMING provides an alternative way of restricting access.

SYSTEM OPTION – DEFINITIONS

GENERAL FUNCTION OPTIONS

ALLOW PLU COPY BY RANGE

The program menu option copy program, allows various details to be copied from one to another such as keyboards, WLUs for PLUs the copy parameters can be set so that a product is copied to another product or to a range or items.

ALLOW POST TENDERING

This allows the recalculation of change for the last sale, by entering the value and pressing Cash

EMPLOYEE POP UP/STAY DOWN

This determines whether an employee remains signed onto the terminal when a sale is completed, this is referred to as stay down. The alternative is pop up which means as soon as a sale is finalised the employee is signed off forcing an employee code to be entered every transaction.

EMPLOYEE SIGN ON

The employees can be signed onto the terminal in various ways. The most common method is to allocate employee buttons these will sign on staff. Alternatively, they can use an employee code button. This allows you to use either the EMPLOYEE number which is the default sequential code or the OPERATING CODE which is a unique code programmed per employee.

QTY LIMIT FOR X/TIME KEY

No multiplication quantity will be accepted which exceeds the value entered here.

EMPLOYEE # LINKED CODE (1- 10)

Ten push button employee sign on keys can be programmed to the keyboard they can be used to sign on any employee with the system. The employee's sequential number is allocated here. This enables that employee to be signed on at the press of a button.

AUTO CLEAR ERROR CONDITION

If set to Yes, error conditions will clear automatically after a momentary error tone displaying an error

GUEST CHECK BALANCE HALO (0=NO LIMIT)

The sales value which can be stored against a tracking value can be restricted to a maximum limit, this can be programmed here for all tracking files 1 – 4 or against each individual store check key. The HALO message will appear to warn the operator the maximum balance has been achieved.

SET DEFAULT SEAT# TO 1

The System can be programmed to enable individual seat allocation per guest for each tracking file. This allows each person to pay, their share of the overall bill. A total will be calculated for each seat

allocated to items on a tracking bill. Normally seat numbers are entered when required, this option will automatically allocate each person seat number 1.

SYSTEM OPTION – DEFINITIONS

GENERAL FUNCTION OPTIONS

CONTINUE MACRO WHEN MACRO IS LOOP

This prevents macros from running in a continuous sequence.

ENTER TIME FOR TRANSACTION VOID

The option to enter the time for voids, is used to ensure that reporting by time periods are correct this is an optional feature for those wishing to manage hourly sales for analysis purposes. This would ensure a void for a sale made at a specific time can be done after that time yet still subtract from the correct hourly totaliser.

START CURSOR AT PRICE 1 IN PLU PGM

When programming PLUs the cursor normal starts at the DESCRIPTION field, this flag will set the cursors starting point as the price field which results in easier fast maintenance programming

SCREEN SAVER (MINUTES)

The display will turn off after the allocated number of minutes, a key press will be required to activate the display.

ALLOW THE PRESS (NEWSPAPER)CODE PLU

This allows the sale of the specialist newspaper barcodes which differ in format from the standard EAN 8 and 13 digit

ALLOW MULTIPLE MULTIPLICATION

Note:- This feature cannot be used with SPLIT PRICING or DIRECT MULTIPLICATION.

The quantity key will allow two entries before the sale of a product, these two entries are then multiplied together to give the total sales quantity for the product i.e. 5 x/time then 10 x/time = 50 items

ALLOW TAX SHIFT BY ANALYSIS 2

Design for the American market to apply tax to fast food sales, the feature forces when the analysis 2 key is pressed the tax programming of the items as standard to be ignored and the tax relating to the analysis key to be applied.

TAX SHIFT ITEM POP UP/TRANS.POP UP

When it is necessary to change the pre-programmed tax rate of an item using the tax shift key, the decision can then be made to allow that change to take place just for the item registered i.e. POP UP, or until another selection is made i.e. STAY DOWN.

BASE CURRENCY LOCAL/EURO

This allows the currency change to EUROS in such time when all monies will no longer be Sterling, Puntos etc. but is always accepted as EUROS

SYSTEM OPTION – DEFINITIONS

GENERAL FUNCTION OPTIONS

ALLOW CLERK INTERRUPT

This when will allow employees to lay away a sale, this enables numerous staff to operate the terminal at once.

ALLOW FLOATING CLERK

This allows employees to use any terminal in a multi EPS site. Commencing a sale on one machine and moving the sale throughout the system for additions etc as they sign onto different terminals.

ALLOW CLERK CHANGE WITHOUT SIGN OFF

This enables the another operator to interrupt the sale in progress without the need of the original operator to sign off, providing a true clerk interrupt principle.

GELDKARTE LOGIN PASSWORD

This is a European feature not used in the UK and related to the German, EFT password.

SKIP IN NOT FOUND PLU REGISTRATION

This allows both the Group link and the Description to be removed from the NOT FOUND prompt required when creating a new product in the register position.

SUBTRACT CHANGE FROM FOREIGN1 TOTAL

This is design for the use of the change over period from home currency to Euros, at such time all home currency will taken out of circulation and the Euros will be given as change.

SYSTEM OPTION – DEFINITIONS

TAX OPTIONS

TAX ROUNDING FACTOR

It is assumed as standard that a tax calculation resulting in more than 3 decimal places will be rounded up/off. This can be changed to round either down or off at the 3rd decimal place.

VAT SUBTRACTED FROM INDIVIDUAL PLU TTLS

This system flag enables product values to be reported exclusive of the vat content.

PRINT TAXABLE AMOUNTS ON R/J

This prints the value of the goods to which tax is to be applied on both the receipts and journals.

TAXABLE STATUS INDICATOR

When an item is linked to a tax rate it is also assigned a symbol relating to the tax table This is to assist viewing of the tax totals on the receipts and relating them back to an individual item. It also serves as a useful check to ensure an item has been successfully programmed to the tax totals.

PRINT TAX AMOUNTS AT TENDER

This determines whether the amount of TAX charged will be printed on the receipt at finalisation.

PRINT VAT AMOUNTS SEPARATELY

This prints the value of the sale net of vat on the receipt.

TAX PRINT Y=COMBINED / N=ITEMIZED

This feature is designed to simplify the receipt issued. When products of different tax rates are sold the tax can be printed separately per rate this is referred to as itemised. Alternatively the total tax due of all the rates can be displayed and printed, this is referred to as combined.

PRINT TAX EXEMPT DESCRIPTOR/TTLS.

When an item is exempt from tax this can be indicated on the receipt by printing both a descriptor and the value of the exempt amount. Tax exemption works in conjunction with function key system flags being programmed.

PRINT SUBTOTAL WITHOUT TAX

When adding tax to sale total, the total can be printed without the tax total added before the tax calculations are printed.

DO NOT SHOW FOOD STAMP INDICATOR

The US market uses food coupons, This option suppresses the food stamp indicator of an individual product.

SYSTEM OPTION – DEFINITIONS

CASH DRAWER OPTIONS

ALLOW SALES WITH DRAWER OPEN

This enables sales to be made even when the drawer is open

C-I-D AMOUNT LIMIT

When the system reaches the programmed limit the machine will warn the operator to take action and perform a PAID OUT sequence to reduce the CASH IN DRAWER Totaliser.

OPEN DRAWER DURING X / Z REPORTS

The cash drawer does not normally open when reports are taken, This system flags opens the drawer at the appropriate times, allowing access to the drawer

ACTIVATE OPEN DRAWER ALARM

This works in-conjunction with the alarm time providing a warning when the drawer is open too long.

OPEN DRAWER ALARM TIME

This is the time limit in seconds that the drawer can be open before the alarm activates.

SYSTEM OPTION – DEFINITIONS

TRAINING MODE OPTIONS

TRAINING MODE PASSWORD

This is the password used to active and de-active the training feature. The training mode option can be found on the X-MODE Menu. Note if the X-mode is not to be used for activating the training for the whole machine then a training employee can be programmed to enable training to operate alongside normal sales.

OPEN DRAWER IN TRAINING MODE

The cash drawer is not normally required to open during staff training. This system flag allows for the drawer to open as normal.

TRAINING EMPLOYEE FILE #

This is the employee number used to provide the training mode employee report totalisers. If a training mode report is required, one of the employee numbers is set aside for reporting purposes this employee is then no-longer used in the register position, but reserved for training mode report printing, usually printed out by selecting reporting of an individual employee number.

ALLOW REAR DISPLAY IN TRAINING MODE

The rear display can be disabled, so that no sales are shown, whilst training is being carried out.

SEND ORDERS TO KP/KV IN TRAINING

Whilst training mode is activated, the kitchen printing is not normally required. This options activates the printing as normal, indicators that training is being given are used to differentiate between normal trading.

PRINT JOURNALS IN TRAINING

Using this system flag it is possible to enable or disable journal printing whilst training is taking place.

PRINT RECEIPTS IN TRAINING

Using this system flag it is possible to enable or disable receipt issuance whilst training is taking place.

PRINT “TRAINING”

The indicator TRAINING is displayed and printed, whilst the training mode is active to show the terminal is not operating in normal registration mode. This indicator can be suppressed.

SYSTEM OPTION – DEFINITIONS

LEVEL/MODIFIER OPTIONS

DEFAULT KEYBOARD LEVEL

The terminal has five completely independent keyboards programmed into the system. This option determines which keyboard will be loaded as standard when the machine is turned on. The LEVEL SHIFT keys will be required to switch from this level to an alternative. Levels can also be defined in X

KEYBOARD LEVEL Y=STAY DOWN / N=POP UP

The switch between keyboard levels can be used in three ways. Firstly STAY DOWN, this is when the new keyboard level selected will remain until an alternative LEVEL SHIFT key is pressed. The second option is POP UP, this forces the return to the default level, when next item is sold, the third option allows the level to stay during one transaction before returning to the original setting.

DEFAULT PRICE LEVEL

The terminal has five prices per product where that price can be allocated from any one of twenty price bands. Price activated for sale using a different price level key per price. This option determines which price level will be loaded as standard when the machine is turned on. The PRICE SHIFT keys will be required to switch from this level to an alternative. Default price Levels can also be defined in the X

PRICE LEVEL Y=STAY DOWN / N=POP UP

The switch between levels can be programmed in three ways. Firstly STAY DOWN, in this instance when a PRICE SHIFT key is used, the new keyboard level selected will remain until the PRICE SHIFT key is pressed. The second option is POP UP, this forces the price to return to the default price level, when for the next item. The third option allows the level to stay during one transaction before returning

PLU MOD KEYS Y=STAY DOWN / N=POP UP

Preceding a PLU entry a modifier key changes one digit of the PLU number, causing a different PLU to be registered. MODIFIER Keys can be set to change either the item code or the description only. For example to modifier the 3 digit of a number by 2 would be 1 = 201 1001 = 1201 etc ideal for different sizes etc i.e. PLU 1 Pint 201 Half Pint etc.. Modifier keys can also be used for a different function. They act as text print keys, modify the description only of a product sold, providing instructions for products to be printed on receipts, KP orders etc. This option is to determine whether the effect a modifier key is to stay active until another selection is made. This is referred to as Stay Down. The alternative is that the change takes effect solely for that product and normal operation will be resumed when the next product is sold. This is called POP UP. The third option allows the level to stay down one transaction before returning to original settings.

APPLY MODIFIER TO CODE ENTRY PLUS

The modifier change of a PLU can be programmed for keyboard items only or keyboard and PLU code

MODIFIER OVERWRITES PREVIOUS MODIFIER

If Y, only the last modifier entry will affect the PLU number. Use this setting when a PLU is modified only once, i.e. small/med/large. If N, several modifiers affecting different digit positions could be entered then affect the PLU registered. For example, size, crust type, and/or toppings could be

SYSTEM OPTION – DEFINITIONS

TRACKING FILE OPTIONS

AUTOMATIC TRANSFER CHECK

This refers to re-assigning a check opened by one employee to another employee. This automation allows transfer when an employee opens a check, or changes the operator whilst a check is open.

CHECKS PAID SLIP IS STUB

This produce an abrieved bill, showing only financial information only.

PRINT GUEST CHECK

This prevents guest bills being printed at the terminal, even if a print check key is programmed, design to program the terminal as a order not payment register.

SELECT HELD ITEMS ON RECALL

The terminal operates a system, which allows the operator to prevent items being printed in the kitchen until requested. This is a feature used in-conjunction with the check tracking files allowing all Held items to automatically be selected ready for printing the moment the check is opened. The items on hold are highlighted when a check is re-opened, eliminating the need to manual select each held item. The next stage pressing of PRINT HOLD will send the items to the printer.

WARN IF HELD ITEMS AT FINALIZE

This indicates to the employee when a bill is being cashed off, that there were items still on hold that had not being printed.

TRACK 2 HOLDS CLOSED CHKS FROM TRACK 1

If this flag is activated, TRACK 2 is not to be used as a normal open check balance storage system. It is an archive for closed checks which were opened on tracking method 1. As a check is closed on tracking method 1, the data is stored in check files 2, available for reporting by printing OPEN CHECK TRACK#2. The maximum file size for data storage is determined by the MAXIMUM NUMBER of checks set in the memory allocation.

TRACK 4 HOLDS CLOSED CHKS FROM TRACK 3

If this flag is activated, TRACK 4 is not to be used as a normal open check balance storage system. It is an archive for closed checks, which were opened on tracking method 3. As a check is closed on tracking method 1, the data is stored in check files 3, available for reporting by printing OPEN CHECK TRACK#4 The maximum file size for data storage is determined by the MAXIMUM NUMBER of checks set in the memory allocation.

STARTING CHECK# 1 – 4

When using the auto check number generation system this is the number from which the checks will begin to be generated, each file can have a different starting number.

SYSTEM OPTION – DEFINITIONS

TRACKING FILE OPTIONS

CHECK# LIMIT 1 - 4

This is the maximum number that can be automatically generated by the terminal, and works in-conjunction with the starting check number, when the limit is reached the message, buffer full will appear until one of the existing checks is finalised.

RESET CHECK # 1- 4 AT (Z1 FINANCIAL, Z1 OPEN CHECK, NEVER)

When running a system with automatic check number generation, the check numbers can be reset back to the starting check number at one of three stages.

SHOW BACKUP MASTER DOWN INDICATOR

If the system is programmed to allow the live check tracking data to be stored in another terminal this will provide an indicator on the register display, showing the situation of the backup terminal, checking the status every time the IRC network is interigated.

SYSTEM OPTION – DEFINITIONS

KITCHEN PRINTING/VIDEO OPTIONS

PRINT AT KP:

TOTAL AMOUNT LINE

The sale total can be printed on the kitchen printer showing the total value for the items printed.

PRINT SEAT#

This provides extra information for waitresses by printing the seat number of the food ordered.

ORDER#

This is especially useful when a check number is not used as the order number identifies what sale/customer the food produced is to be served to. This can also be used as a global order number providing a central consecutive number for all food orders printed in the kitchen.

TRANSACTION VOID ITEMS

This will print items/sales removed from a sale to the kitchen printer indicating those items are no longer required.

PLU CODE

This will print the PLU number alongside the description on the printer.

PLU PRICE

This will print the price of the product alongside the description on the kitchen printer, when used with the total amount line print, this provides a good substitute for a sales receipt.

ENABLE SORT KP BY KP GROUP #

The information is printed on the kitchen printer in the order the food was sold; however this may not necessarily be a logical order for the chef. It is possible using this system flag to identify the preparation group it refers to i.e. starter, main courses etc. A sale that is then entered in a random order will be re-sorted by the preparation group.

LINE FEED AT BEGIN OF KP PRINT

It is possible to feed the paper before information is printed; this in-turn makes the receipt issued longer. This system flag relates to items printed on the Kitchen Printer and not to the receipt.

LINE FEED AT END OF KP PRINT

It is possible to feed the paper after information is printed; this in-turn makes the receipt issued, longer. This system flag relates to items printed on the Kitchen Printer and not to the receipt

SEND ORDERS TO KP ON SUBTOTAL

This flag show items on the Kitchen Printer when the SUBTOTAL key is pressed.

COMBINE LIKE ITEMS ON KP OR KVS

The same product can be printed separately when more than one has been sold or print consolidation on one line with a quantity and total value. This also applies to the kitchen video as well as the printer.

SYSTEM OPTION – DEFINITIONS

KITCHEN PRINTING/VIDEO OPTIONS

SEND ORDERS TO KVS ON SUBTOTAL

This flag show items on the Kitchen Video System when the SUBTOTAL key is pressed.

PRINT VOIDED ORDERS AT KP OR KVS

When food is no longer required. This options means items, voided on the terminal, are printed.

KP IS Y=REAL TIME / N=BATCH

This flag controls when the items are printed to the kitchen printer. If the real time option is selected each item will be printed the moment it is sold; this results in one receipt per product. The alternative is to select batch printing, which prints items when the sale is complete producing a ticket for all items

KVS IS Y=REAL TIME / N=BATCH

This flag controls when items are to be displayed on the Kitchen Video System. When Real time is selected the items are displayed. The alternative is batch, items are then shown at the end of sale

USE KP ROUTER (THE SAME FOR ALL REG, SEPARATELY)

The terminal has the capability of four pages of kitchen printer output settings, each controlled by time, manually using the KP routing key or the analysis keys. The four pages can apply to the whole network, or each terminal can have four completely independent pages.

KP ORDER# COMBINATION OF REG#&CONS# or GLOBAL

The order number can be either the register and consecutive number combination or used as a global order number providing a central consecutive number for all food orders printed in the kitchen.

DISPLAY KP TIME PERIOD#

This indicates on the register display, which one of the four printer pages is currently being printed to.

DISPLAY KP ORDER#

The order number being currently printed in the kitchen can be displayed on the register display.

SEPARATE KP BY KP GROUP#

Each product is linked to a kitchen print group, these groups are then allocated to the appropriate printer separate printers, can print any group once or upto nine times. This will print a receipt for each group.

SEPARATE BY KP ITEM

A separate kitchen ticket can be issued per product, producing one order receipt per item.

SYSTEM OPTION – DEFINITIONS

VALIDATION/SUBTOTAL OPTIONS

VALIDATION AMT: Y=TOTAL / N=TENDER

When a sale requires validation the information printed can be one of two things either the total value of the sale or the value of money received/tendered.

CHK VALID AMT: Y=TOTAL / N=TENDER

When a cheque requires validation the information printed can be one of two things either the total value of the sale or the value of money received/tendered.

ACTIVATE VALIDATION SENSOR

Validation can take place with or without a sensor being activated, the sensor is only required to be activated if operators require guidance as to whether the paper is inserted correctly. The availability of a sensor will also be dependent on the type of printer being used.

ALLOW MULTIPLE VALIDATIONS

It is normal that an operator validates a sale only once for example cheques, however if this were used for tickets it may be necessary to validate the information onto multiple sheets.

PRINT VALIDATION MESSAGE

In addition to the sale being printed, there can also be a pre-programmed message printed.

PRINT SUBTOTAL WHEN SUBTOTAL KEY IS PRESSED.

Subtotal is normally printed at finalisation this however allows a subtotal to be printed whenever the key is pressed, providing mid sale totals as well as the final subtotal.

VALIDATION PORT# (0 –7)

This is the physical port number through which the validation printer is connected

SYSTEM OPTION – DEFINITIONS

GENERAL PRINTING OPTIONS

PRINT ON RECEIPT:

This controls what will be printed on the receipt ticket.

EMPLOYEE NAME

This programs whether the employee name will be printed on the receipt

CONSECUTIVE #

This programs whether the consecutive transaction number will be printed on the receipt

Items by Group

The products can be printed on the receipt in the order they were entered or in the sorted into their group, i.e. all food together, then all drinks, they are sorted using the PLU programmed Group#1

DATE

This programs whether the date will be printed on the receipt

TIME

This programs whether the time will be printed on the receipt

PREAMBLE/POSTAMBLE

It is possible to print a message at the top of the receipt; this is referred to as the PRE-AMBLE message. It is also possible to print a message at the bottom of the receipt this is referred to as the POST-AMBLE message. This programs whether the messages will be printed.

ORDER #

This programs whether the ORDER # will be printed on the receipt

SEAT #

This programs whether the SEAT # will be printed on the receipt

RECEIPT FEED LINES AFTER PRINT

The receipt can be increased in length by enter the number of extra lines to feed after printing. This applies only to receipt print, not kitchen printing. If an overall number of lines feed are required for the printer whatever the print, it is programmed in s-mode port definition.

LINES AFTER PREAMBLE

It is possible to print a message at the top of the receipt; this is referred to as the PRE-AMBLE message. This programs how many extra lines are fed after the message before sales details

LINES BEFORE POSTAMBLE

It is possible to print a message at the bottom of the receipt this is referred to as the POST-AMBLE message. This programs how many extra lines a fed before printing the bottom logo message.

BUFFERED RECEIPT: Y=STUB / N=FULL

When the receipt is printed after the sale is completed i.e. buffered the information printed can be an abbreviated financial stub or a full-itemised receipt.

SYSTEM OPTION – DEFINITIONS

GENERAL PRINTING OPTIONS

PRINT RECEIPT WHEN SIGNING ON/OFF

It is possible to issue a receipt for each employee that signs into the system for registration

PRINT RECEIPT WHEN CLOCKING IN/OUT

It is possible to issue a receipt for each employee that clocks into the system for time clocking

CONDENSE TRAY SUBTOTAL RECEIPTS

The system has a function called tray subtotals. This allows users to press a key; to issue a receipt for the items sold since the last press of the tray subtotal key. The sale is continued tray subtotal is again within the sales to issue receipts for further items. It is then possible to finalise and receive a completed receipt. This feature is ideal when a ticket is required for items within a sale, as well as a payment receipt for the whole transaction. This option allows the printed information to be condensed, reducing the amount of paper used

JOURNAL Y=REAL TIME / N=BATCH

The timing of the print to the journal can be controlled; real time means the moment a product is sold the information is printed. The alternative is batch printing; the information is printed at the end of sale.

PRINT PLU CODE WITH DESCRIPTOR

It is assumed not necessary as standard to print the product code of the item sold, as most clients do not refer to the code number. However in a scanning system or a retail environment this information may be required in addition to the product description. This flag print the product code number every time the description is printed. I.e. when the product is used.

TRANSACTION # IS RANDOM NUMBER

The receipt identifying number can be changed from sequential to random if required.

HOME CURRENCY SYMBOL

The monetary symbol for the country in which the machine is based. I.e. £s , Pts, etc.

CONVERTED CURRENCY 1 SYMBOL

The symbol printed when money is entered using currency conversion key 1. Conversion one is the rate used for EURO conversion.

CONVERTED CURRENCY 2 - 5 SYMBOL

The symbol printed when money is entered using currency conversion key 2 - 5

SYSTEM OPTION – DEFINITIONS

GENERAL PRINTING OPTIONS

PRINT TENDER ON RECEIPT

This controls whether the amount given by the customer for payment is printed on the receipt or whether the sales total only is displayed.

DISABLE LINE FEED ON SLIP PRINTER

The slip printer is especially design to take loose-leaf paper, and automatically print in the appropriate position for a check on the paper. The position can be manually modified using a LINE FEED key. This option prohibits manual override.

GUEST CHECK PREAMBLE/POSTAMBLE

There are two types of logo messages, the standard sales receipt message, or the alternative guest bill check tracking message. This option decides which is to be used. I.e. the same sales receipt logo message on all prints outs, or a specific guest check message to be printed on bill. This may include messages like TIPS ARE AT YOUR DISCRETION, PLEASE SIGN HERE etc... not normally required on a standard sales receipt.

PRINT RECEIPT AUTOMATICALLY

When the receipt is switched on, a sales receipt will be issued either every time a sale is made i.e. automatically. or when the Receipt Issue key is pressed. If the receipt switch is turned off neither of the options apply. This flag when set to Y will issue a receipt every time a sale is made, whilst the receipt is on. The alternative being pressing the receipt issuance key.

PRINT RECEIPT AFTER TIME CLOCK EDIT

This is an option receipt print when the time clock wages data is edited manually in the X-MODE.

PRINT GROUP NAME WHEN PRINTING ITEMS BY GROUP

When the receipt is sorted by group it is possible to have the group name printed at the top of each group section.

PRINT GUEST CHECK PRINT COUNT ON GC

This will print at the bottom of each bill produced the number of times the bill has been issued.

PRINT AS FOREIGN CURRENCY 1

Foreign Currency 1 is normally the Euro's, this feature helps deal with the necessity of dual pricing in Euro's. Each of the following determines when the home currency rate is to be printed alongside with the EURO total.

TOTAL	This prints the total of the sale in Euro's as well as home currency
TENDER	This prints the value of monies given in payment in Euro's as well as home currency.
CHANGE	This prints the total of change given in Euro's as well as home currency.

SYSTEM OPTION – DEFINITIONS

GENERAL PRINTING OPTIONS

DISABLE PRINTING IN CURRENCY CONV.

When converting a total from home currency to a foreign currency, there is standard information printed, the following can be suppressed.

CHANGE RATE	This is the current rate of exchange used for the conversion
FOREIGN AMOUNT	This is the value entered for payment in the foreign currency.
HOME AMOUNT	This is the value entered for payment in foreign currency converted to the equivalent in home currency.

PRINT ALL CURRENCY IN CONV2-5 OPERATION

This allows when using EUROS dual pricing and payment in a furthe currency to print both the information in EUROS also in the currency by which the sale is to be paid.

TOTAL	This prints the total of the sale in Euro's as well as home currency
TENDER	This prints the value of monies given in payment in Euro's as well as home currency.
CHANGE	This prints the total of change given in Euro's as well as home currency.

SYSTEM OPTION – DEFINITIONS

REPORT PRINTING OPTIONS

ZERO SKIP (ALL OPTIONS)

This prevents unused items for printing on the report, it is advisable these features are turned on, as the reports will increase dramatically in length if no zero skip is performed.

PRINT % OF SALES ON PLU REPORT

The product report prints as standard the quantity and value sold per product this can then be used to calculate the percent value of total sales that item has achieved.

PRINT LINKED GROUPS ON PLU REPORT

The products can be linked to groups for sales analysis by category; it is possible to print this number on the report to help identify the product category.

PROMO/WASTE TOTALS ON PLU REPORT

It is possible to print along side the products sales information the quantity of items that have been issued as wastage, also the number of items that have been sold as promotional products.

INDIVIDUAL ITEM USAGE QTY ON PLU REPORT

This will print not only the total quantity sold, but also the total usage which is calculated from an addition of quantity sold + Promotion Products + Wastage items.

COUNT ON TIME REPORT IS CUSTOMER / GUEST

The hourly report indicates the value of sales made during that time. The counter can be either the total number of transactions per hour referred to as the customer count. The alternative is using the GUEST# key totalling the number of entries, i.e. how many people have visited the establishment.

USE FUNCTION KEY DESCRIPTOR IN RPT

This allows a different description to be used during registration to that printed on the reports. When the default description of the function key is change from the default settings this alternative description will print during registration, the choice is then whether the description is to be used for reporting or whether the default settings are to be used.

PRINT MINIMUM STOCK RPT AFTER FINANCIAL RPT

This will print for those products program as stock items with a minimum stock figure, the status of the stock for those below minimum this will appear at the bottom of the financial report, resetting the minimum stock report when the financial report is issued as a Z, ie. Assuming that the stock items have been re-ordered and are no longer required on the minimum stock report.

SYSTEM OPTION – DEFINITIONS

REPORT OPTIONS

ONLY TTL ON PRODUCT MIX GROUP RPT

The product mix groups are used to identify item usage and sales of selected products by time range. This flag changes the format of the report for a time period analysis per product group to a total analysis per group, reducing the length of the report.

ONLY ITEMS WITH ACTUAL INV ENTRY

This will when set only print out ingredients which have had the actual stock figures entered for them, ie only those items which have had stock counted and entered.

CASH DECLARATION COMPULSORY

This system flag forces the operator to enter the value of moneys in the drawer before reporting

SIGN ON EMPLOYEE BEFORE REPORTS

It is not compulsory for an employee to be signed into the system before producing a report. However if extra security is required, this flag can be activated forcing employee sign on before reporting

ENFORCE ACTUAL INVENTORY BEFORE Z1

This forces the current stock situation for each ingredient to be entered before reporting

RETAIN ACTUAL INV ENTRIES IN X1

This prevents the ingredient stock figures entered in X mode prior to the report being from being cleared, I.e. once the current stock situation has been entered and a variance report produced should this information be retained or cleared.

RESET PLU REPORT AT INVENTORY Z1

This will reset the PLU sales quantity and value report when reset ingredient inventory information. This should be considered carefully as an option, ensuring that your intentions are to reset PLU sales

RESET INVENTORY REPORT AT PLU Z1

This will reset the ingredient inventory data when the PLU sales quantity and values are reset. This should be considered careful as an option, ensuring that your intentions to rest the information is what you require.

TIME KEEPING Y=MINUTES / N=100 UNITS

The clocking In/Out option can calculate labour costing based on minutes or 100s of an hour, Minutes are option most commonly required In the UK.

OMIT TAX TOTALS FROM NET SALES GT

The system a running financial totals this, as standard will include any tax charged. This can be omitted

SYSTEM OPTION – DEFINITIONS

REPORT OPTIONS

ALLOW Z OF OPEN CHECKS REPORTS

The system assumes that all checks opened will be paid it is possible to allow or disallow clearing of these.

CONFIRM BEFORE TOTALS RESET ON Z

If this flag is set the system will request a key press once a Z report is run to active clearing of the totals. It is a security measure to ensure the operator is aware of their actions.

RESET AFTER FINANCIAL Z REPORT

GROSS SALES GT

This is the running total of the retail value of goods sold. It is not normally reset when a financial report is issued, as its purpose is to provide an on going GRAND TOTAL

NET SALES GT

This is the running total of the monetary value of goods sold. It is not normally reset when a financial report is issued, as its purpose is to provide an on going GRAND TOTAL

NEGATIVE SALES GT

This is the running total of all negative products sold. It is not normally reset when a financial report is issued, as its purpose is to provide an on going GRAND TOTAL

Z COUNTER

This counter is used to show the total and number of each type of report that have been taken. Resetting starting the numbering each time a Z report is taken.

CONSECUTIVE #

This counter is used to number each receipt that has ever been issued. Resetting start the numbering each time a Z report is taken.

VOID MODE TOTALS ADD TO GRAND TOTALS

The running grand totals are totals of sales and financial information for goods and moneys received; Voids are normally deducted from these totals It is possible to reverse this and add voids taken to the totals. It is not the norm to set this flag; there are certain environments where it is applicable.

ALLOW Z WITH OPEN ORDERS

It is possible to decide whether the system will allow resetting of the terminal when there are open balances.

SYSTEM OPTION – DEFINITIONS

TIME KEEPING OPTIONS

OVERTIME HOUR IS USED FOR DAY OR WEEK

Overtime can be paid on the number of hours worked per day or week. I.e. 8 hours a day or 37 hours per week.

HOURS PER OVERTIME STARTS

Once an employee's total hours worked have reached this point then an overtime rate will be paid.

OVERTIME FACTOR

This is the ratio of the pay rate for overtime for example 1.5 will indicate time and a half.

ENFORCE (OUT FOR BREAK) OR (EXIT) ENTRY

This enforces the employee to enter why they are clocking out either for a break or to clock off

TIP REPORTING % OF SALES

The tips earned can be calculated as a ratio of sales that each employee has achieved. This is the percentage value employees will earn

EMPLOYEE TIME IN/OUT – SECRET CODE

There are various employee restrictions to clocking on to the system. The standard register sign on code can be used as the clock in code, or an alternative separate clock in code can be allocated. This option determines which code is to be used for time in/out operation.

SYSTEM OPTION – DEFINITIONS

E.J. & DETAIL PRINTING OPTIONS

ACTIVATE ELECTRONIC JOURNAL

This enables the electronic journal, storing all actions made on the terminal can be stored to the memory for reporting.

DISPLAY E.J. BUFFER FULL WARNING

The terminal has a maximum number of lines which is allocated in the initial memory allocation. When this is reached the terminal can display a warning indicating it is time to take a reset report

E.J. OVERRIDE WHEN BUFFER FULL

When the maximum limit is reached a reset can be forced to clear the totals. The alternative is to start at the oldest information stored and begin to overwrite the information, providing a continuous loop. It should be noted, the oldest data is overwritten and cannot be reported on.

SEND TO ELECTRONIC JOURNAL

This terminal has a very sophisticated analysis on journal reporting. All information can be sent to the terminal and when reported extracted as required i.e. all Cash Transactions, VOIDs etc. The alternative here is to send only to the journal the information that you require. This will save on the memory required, as only part information is stored. The system then ceases to operate as a true journal of all transactions but provides a monitoring system for the information that you require tracking. The choices available are.

- | | |
|---------------------------------|--|
| CASH TRANSACTIONS | - All cash sales made during normal operation |
| CHEQUE TRANSACTIONS | - All check sales made during normal operation |
| MISC TENDER TRANSACTIONS | - All Miscellaneous sales made during normal operation |
| TRANSACTIONS WITH % | - All sales containing a discount or premium operation |
| RECD ACCT & PAID OUT | - All received on account or Paid out sales transactions |
| RETURN TRANSACTIONS | - All Merchandise Return sales transactions |
| TRANSACTIONS WITH | - All Transactions containing an error correct or void. |
| ERR CORRECT & VOID | |
| NO SALES | - All Transactions containing no sale operations. |
| CANCEL TRANSACTIONS | - All Register Mode cancelled transactions |
| TRANSACTIONS WITH | - All Transactions with negative product sales. |
| NEGATIVE ITEMS | |
| REPORTS | - All Read & Reset reports which are printed |
| PROGRAM SCANS | - All Program scans, which are printed. |
| CHECK TRACKING | - All movement on open checks can be stored |

SEND TO DETAIL

When an electronic journal is not used, it is possible to use a detailed audit printer the following information can be prevented from printing.

- | | |
|--------------------------|--|
| TRANSACTIONS WITH | - All transactions with negative products |
| NEGATIVE ITEMS | |
| REPORTS | - All Read and Reset reports which are printed |
| PROGRAM SCANS | - All Program scans which are printed. |

TAX

Tax can be programmed as; addition where the value of tax is added to each products retail price or extraction where the system calculates the amount of VAT included within a sale

P-MODE PROGRAMMING MENU	L1
1. PLU	
2. PLU STATUS GROUP	
3. GROUP	
4. FUNCTION KEY	
5. SYSTEM OPTION	
6. TAXES	
7. MESSAGES	
8. WINDOW LOOK UP (WLU)	
9. TIME PERIOD	
10. EMPLOYEE	
11. AUTHORITY LEVEL	
12. PRINTER TABLES & KV ROUTING	
▼	ENTER PAGE UP/DN ↑↓

TAX PROGRAMMING	L1
1. TAX 1	ADD ON
2. TAX 2	TAX
3. TAX 3	TABLE
4. TAX 4	ADD ON
5. TAX 5	ADD ON
6. TAX 6	ADD ON
ESC ENTER PAGE UP/DN ↑↓	

TAX#1 BY VAT	L1
RATE	17.500
ESC Y/N ENTER PAGE UP/DN ↑↓	

MESSAGES

Various text can be reprogrammed changing the default settings. It is also possible to program receipt and bill header/footer messages in this section

P-MODE PROGRAMMING MENU	L1
1. PLU	
2. PLU STATUS GROUP	
3. GROUP	
4. FUNCTION KEY	
5. SYSTEM OPTION	
6. TAXES	
7. MESSAGES	
8. WINDOW LOOK UP (WLU)	
9. TIME PERIOD	
10. EMPLOYEE	
11. AUTHORITY LEVEL	
12. PRINTER TABLES & KV ROUTING	
▼	ENTER PAGE UP/DN ↑↓

MESSAGES MENU	L1
1. LOGO MESSAGE	
2. ERROR MESSAGE	
3. SYSTEM DESCRIPTORS	
4. REPORT DESCRIPTORS	
5. CHEQUE ENDORSEMENT MESSAGE	
6. GUEST CHECK LOGO MESSAGE	
7. VALIDATION MESSAGE	
	FSC ENTER PAGE UP/DN ↑↓

LOGO MESSAGES

Used to program the sales receipt Post-amble header message and Pre-amble footer message, The justification selection can be used to auto centre etc the programmed message.

ERROR MESSAGES

This can be used to change the default error message to your own custom requirements.

SYSTEM DESCRIPTORS

This contains the terminal's default descriptions such as SUBTOTAL, TAXES etc. This option can be used to change the default settings to your own custom messages.

REPORT DESCRIPTORS

This can be used to change the default report descriptions such as GROSS, NET etc to your own requirements.

CHEQUE ENDORSEMENT MESSAGE

This can be used to program the message that will be printed on a check when the endorsement key is used.

GUEST CHECK LOGO MESSAGE

Used to program the guest bill tracking receipt Post Header message and Pre-amble footer message, The justification selection can be used to auto centre etc the programmed message. The option to use guest message or receipt message when printing a bill is programmable in the system options

VALIDATION MESSAGE

Used to print a message when the validation feature is in use.

DEFAULT ERROR MESSAGES

NO.	DESCRIPTION	NO.	DESCRIPTION
1	(NOT USE)	111	NEGATIVE CARD
2	(NOT USE)	112	LINKED STATUS REQUIRED
3	AMOUNT REQUIRED	113	RETURN TO X-MODE
4	BAD VALUE	114	ERROR - SLIP PAPER
5	BUFFER FULL	115	LOCAL PRINTER REQUIRED
6	BUFFER EMPTY	116	MODE ERROR
7	BUSY	117	SET TIME&DATE IS DECATIVATED
8	BAD COMMAND	118	EMPLOYEE SHOULD BE DIFFERENT
9	CASH DECALATION REQUIRED	119	TRANSFER NOT ALLOWED
10	CASH-IN-DRAWER EXCEEDED	120	REQ GALLONAGE AMOUNT
11	CHECK# ASSIGNED AUTO	121	AVAILABLE ONLY IN CHECK
12	CHECK# REQUIRED !	122	SPLIT THIS ITEM NOT POSSIBLE
13	CONDIMENT REQUIRED!	123	FUNCTION KEY NOT INCLUDED
14	CRC ERROR	124	ERROR POST TENDER
15	DUPLICATE!	125	NO TRACKING DATA IN THIS REG
16	ANALYSIS1/2/3	126	NO TIME KEEP DATA IN THIS REG
17	ENTER EMPLOYEE CODE	127	MULTIPLICATION LIMIT EXCEEDED
18	ENTER EMPLOYEE #	128	TAB OF FIELD2 TOO BIG
19	ENTER GUEST COUNT	129	NON-PLU CODE RANGE OVER
20	ENTER SEAT#	130	TARE ENTRY NOT ALLOWED
21	ENTER TABLE#	131	MISC TEND REQUIRED
22	ENTRY REQUIRED	132	SAME CHECK TRACK REQUIRED
23	ERROR	133	NOT SCALEABLE PLU
24	ERROR JAM	134	EJ BUFFER FULL
25	TABLE NUMBER IN USE	135	MUST BE START<=END IN RANGE
26	HALO OVER!	136	RANGE OVERLAP
27	ILLEGAL KEY SEQUENCE	137	FINAL END SHOULD BE 9 OR 99
28	IN USE!	138	NOT PLU
29	INACTIVE!	139	NOT WLU
30	INPUT QTY	140	PRINT KEY REQUIRED
31	KITCHEN PRINTER FAILURE	141	SURCHARGE NOT ALLOWED
32	MANAGER REQUIRED	142	DECIMAL ENTRY REQUIRED
33	MANAGER OVERRIDE REQUIRE	143	SYSTEM REG# REQUIRED
34	MEMORY FULL	144	TRAINING EMP FILE# REQUIRED
35	NEGATIVE	145	TIME IN/OUT REG# REQUIRED
36	NO CHECK#	146	CHECK TRACKING REG# REQUIRED
37	NO DATA	147	ELECTRONIC JOURNAL INACTIVE
38	NO DRAWER!	148	CHEQUE ENDORSEMENT REQUIRED
39	NO MANUAL ENTRY	149	EFT TERMIANL TRANS. KEY ERROR
40	NO PAPER	150	CARD ERROR
41	NO PLU!	151	PRINTER OFFLINE
42	NON ADD# REQUIRED	152	KV OFFLINE
43	NOT DISCOUNTABLE	153	NO RELOCATABLE KEY
44	NOT PROGRAMMED!	154	CLERK KEY ERROR
45	NOT READY!	155	ENFORCE ACTUAL INVENTORY
46	NOT ZERO	156	AUTHORITY LEVEL NOT LINKED
47	OFF LINE!	157	WEIGHT IS ZERO
48	OPEN DRAWER	158	STOCK IS NOT ZERO
49	P/BAL REQUIRED	159	CLEAR CAN NOT BE REMOVED
50	PAPER END	160	ENTER CAN NOT BE REMOVED
51	RANGE OVER	161	YES/NO CAN NOT BE REMOVED
52	REMOVE PAPER	162	THIS NUMERIC CAN'T BE REMOVED
53	SCALE FAIL!	163	INCORRECT CODE

DEFAULT ERROR MESSAGES

54	SCALE REQUIRED!	164	SOFT CHECK ONLY
55	SINGLE ITEM!	165	INACTIVE PLU
56	SUBTOTAL REQUIRED	166	MULTIPLE DISCOUNT NOT ALLOWED
57	SYSTEM ERROR	167	NEW CHECK OPENED
58	TARE# REQUIRED	168	NO MORE SPLIT TENDER ALLOWED
59	TRAY SUBTOTAL REQUIRED!	169	CHECK POLE DISPLAY
60	VALIDATION REQUIRED	170	MUST MAX.NONTAXABLE<=BRK PNT1
61	WASTE REQUIRED!	171	MUST BRK PNT n <= BRK PNT n+1
62	WRONG EMPLOYEE	172	NOT ALLOWED WITH OPEN ORDERS
63	SIGN OFF REQUIRED	173	NOW POLLING !!
64	ZERO AMOUNT	174	INCORRECT TARE WEIGHT
65	PRICE LEVEL MISMATCH	175	MIX AND MATCH ERROR
66	OVERRIDE NOT ALLOWED	176	CLERK INTERRUPT ERROR
67	WRONG SEQUENCE	177	CHECK OPENED NO DATA
68	WRONG COMMAND	178	NO CLERK BUFFER IN THIS REG
69	WRONG FILE NO		
70	WRONG ITEMIZER		
71	UNDER TEND NOT ALLOWED		
72	OVER TEND NOT ALLOWED		
73	CHECK TRACKING ERROR		
74	USING		
75	PLU NOT ALLOWED		
76	CONDIMENT PLU NOT ALLOWED		
77	NON-CONDIMENT PLU NOT ALLOWED		
78	FUNCTION KEY NOT ALLOWED		
79	THIS KEY NOT ALLOWED		
80	NO FUNCTION KEY		
81	NO PROGRAMMABLE KEY		
82	X/TIME REQUIRED		
83	INVALID AUTHORITY LEVEL		
84	TIME IN REQUIRED		
85	SIGN ON REQUIRED		
86	MEMORY NOT ALLOCATED		
87	THIS EMP. RPT MUST BE CLEARED		
88	ERROR STATUS		
89	ERROR VALUE		
90	ERROR SYSTEM OPTION		
91	ERRRR EMPLOYEE		
92	ERROR TABLE NO		
93	SCALE MOTION		
94	OVER WEIGHT		
95	UNDER WEIGHT		
96	PROMO NOT ALLOWED		
97	WASTE NOT ALLOWED		
98	NO FOOD STAMP AMOUNT		
99	DECIMAL ENTRY NOT ALLOWED		
100	SPLIT PRICING NOT ALLOWED		
101	VOID MODE IS DEACTIVATED		
102	JOB CODE REQUIRED		
103	JOB CODE CHANGE NOT ALLOWED		
104	PUSH BUTTON ENTRY REQUIRED		
105	EMPLOYEE CODE NOT LINKED		
106	TENDERING IS NOT ALLOWED		
107	OVER REGULAR HOURS PER WEEK		
108	MUST <= LINE# PER TRANSACTION		
109	MUST >= LINE# PER SOFT CHECK		
110	NO STOCK PLU		

DEFAULT SYSTEM DESCRIPTORS

NO.	DESCRIPTION	NO.	DESCRIPTION
1	SUN	55	PAYMENT
2	MON	56	HOME AMT
3	TUE	57	FSCRT
4	WED	58	FS EXMT
5	THU	59	SCALE CANCEL
6	FRI	60	TIP PAID OUT
7	SAT	61	TIP DECLARED
8	MGR	62	TAXABLE 1
9	TAXES	63	TAXABLE 2
10	TOTAL	64	TAXABLE 3
11	FSTAX	65	TAXABLE 4
12	FSTTL	66	TAXABLE 5
13	FSCNG	67	TAXABLE 6
14	DATE	68	TAX1 AMT
15	TIME	69	TAX2 AMT
16	NO.	70	TAX3 AMT
17	CASH	71	TAX4 AMT
18	CHEQ	72	TAX5 AMT
19	MISC	73	TAX6 AMT
20	REG	74	VAT1 AMT
21	PLU#	75	VAT2 AMT
22	PBAL	76	VAT3 AMT
23	SEAT#	77	VAT4 AMT
24	ESC	78	VAT5 AMT
25	TBL	79	VAT6 AMT
26	GST	80	EXEMPT TAX1
27	EMPL.	81	EXEMPT TAX2
28	FOR	82	EXEMPT TAX3
29	AMOUNT REQUIRED	83	EXEMPT TAX4
30	*****TRAINING*****	84	EXEMPT TAX5
31	TIME CLOCK – IN	85	EXEMPT TAX6
32	TIME CLOCK – OUT	86	TAX TOTAL
33	EMPLOYEE SIGN ON	87	NO SEAT
34	EMPLOYEE SIGN OFF	88	POST TENDER
35	DECLARE CASH TIPS	89	SYSTEM
36	↑↓←→ ENT	90	BALANCE
37	↑↓←→ ENT DONE	91	CHECK#
38	↑↓←→ ENT X/TM	92	CLOCK OUT
39	↑↓←→ ENT DONE X/TM	93	CLOSED
40	ADD CHECKS FOR PAYMENT	94	PRICE/HALO
41	** NOT CLOSED CHECKS **	95	DESCRIPTOR
42	ENTER NEW SEAT#	96	LINK GROUP
43	EMPLOYEE	97	LINK STATUS
44	AMT DUE	98	CHANGE RATE
45	CHANGE	99	FOREIGN AMT
46	JOB CODE	100	REG MODE
47	SUMMARY	101	VD MODE
48	OUT FOR BRK	102	MGR MODE
49	OUT	103	CONV
50	OPERATOR	104	GAS CNT
51	NON-ADD#	105	GAS AMT
52	INPUT QTY	106	ORDER#
53	ENTER TIME:	107	REPRINT
54	TRANS VD	108	GROUP0
		109	DELETED PLU

WLU – WINDOW LOOK UP

There are three types of items that can be found on a Window Look-Up (WLU): condiments, functions, and PLUs. The same WLU can contain any combination of condiments, functions, and PLUs.

Specific features and rules for WLUs are summarised below:

- A specific WLU can be activated automatically after a PLU is entered.
- A specific WLU ,can be activated by pressing a WLU key on the keyboard. Or, by placing the WLU# key on the keyboard, any number of WLUs can be accessed by typing the WLU number and pressing the WLU# key.
- A WLU can be linked to a subsequent WLU in order to prompt an operator through a sequence of selections.
- The order in which items appear on a WLU can be controlled by adding them in a specific order. Items can be deleted, or items can be added in the middle of a list.
- The total number of WLUs and the capacity of each WLU is set in memory allocation.

P-MODE PROGRAMMING MENU		L1
1.	PLU	
2.	PLU STATUS GROUP	
3.	GROUP	
4.	FUNCTION KEY	
5.	SYSTEM OPTION	
6.	TAXES	
7.	MESSAGES	
8.	WINDOW LOOK UP (WLU)	
9.	TIME PERIOD	
10.	EMPLOYEE	
11.	AUTHORITY LEVEL	
12.	PRINTER TABLES & KV ROUTING	
▼		ENTER PAGE UP/DN ↑↓

WLU#	1 PROGRAMMING	L1
1.	TITLE :	STARTERS
2.	ALLOW CONDIMENT	Y
	ALLOW PLU	Y
	ALLOW FUNCTIONS	N
3.	# OF ITEM CHOICES (0=UNLIMITED)	00
4.	ITEM MULTIPLICATION?	N
5.	ALLOW EXIT FROM TABLE WITH DONE?	Y
6.	LINK TO WLU# (0=NO LINK)	00
EDIT ITEMS		
ESC Y/N ENTER PAGE UP/DN ↑↓		

WLU#	1 PROGRAMMING	L1
	PLU/COND NO	
	THEN PLU KEY	
	OR PRESS KEY	
	OR FROM LIST	
	PLU=LIST PLUS	
	ESC=LIST FUNC	
	PLU=LIST COND	
	ERR.CORR. KEY	
	TO DELETE	
	DONE TO EXIT	
		STARTERS
		1 SOUP
		2 MELON
		3 SALMON
		4 PATE
		5 SORBET
		6 SALAD
		7 JUICE
		8 PRAWN COCKTL
		9 SPECIAL 1
		10 SPECIAL 2
		↑↓←→ ENT DONE

WLU – WINDOW LOOK UP DEFINITIONS

WLU#

This is the sequential window number, used to program the WLU key to the keyboard, or to allocate to a PLU for pop up windows, or for reigstration by code using the WLU key.

TITLE

This is the name of the window for display purposes only

ALLOW CONDIMENT

This decides whether the window is to include condiment PLUs (cooking instructions)

ALLOW PLU

This decides whether the window is to include PLUs

ALLOW FUNCTIONS

This decides whether the window is to include function keys

OF ITEM CHOICES

If you select 1 in this field, when a condiment is selected from the WLU, the WLU is automatically closed. In the same manner, if you select 2, the WLU is automatically closed after the second WLU is registered. If you select 0, any number of selections can be made, The WLU is then closed by pressing **DONE**.

ALLOW EXIT FROM TABLE WITH DONE

This allows the user to leave the window without fulfilling all the compulsory requirements such as number of choices.

LINK TO WLU#

It is possible to link windows together, so that when the requirements of one window has been completed the next window is displayed.

TIME PERIOD

Memory allocation determines whether there are 24, 48, or 96 time periods. Time periods will default to hourly periods if 24 periods are selected in memory allocation; 30 minute periods if 48 periods are selected; 15 minute periods if 96 periods are selected. Periods can be set to custom lengths using this program. If fewer periods are needed than are available, unneeded periods can be made inactive so that they will not appear on reports. To make inactive a period, replace the "Y" (active) for the period with an "N" (inactive). All time units are based upon a 24 hour clock

P-MODE PROGRAMMING MENU	L1
1. PLU	
2. PLU STATUS GROUP	
3. GROUP	
4. FUNCTION KEY	
5. SYSTEM OPTION	
6. TAXES	
7. MESSAGES	
8. WINDOW LOOK UP (WLU)	
9. TIME PERIOD	
10. EMPLOYEE	
11. AUTHORITY LEVEL	
12. PRINTER TABLES & KV ROUTING	
▼	ENTER PAGE UP/DN ↑↓

TIME PERIOD PROGRAMMING	L1
# OF PERIODS SET IN MEMORY : 24	
1 <input checked="" type="checkbox"/> 00:00 – 00:59	13 (Y) 12:00 – 12:59
2 (Y) 01:00 – 01:59	14 (Y) 13:00 – 13:59
3 (Y) 02:00 – 02:59	15 (Y) 14:00 – 14:59
4 (N) 03:00 – 03:59	16 (Y) 15:00 – 15:59
5 (N) 04:00 – 04:59	17 (Y) 16:00 – 16:59
6 (N) 05:00 – 05:59	18 (Y) 17:00 – 17:59
7 (N) 06:00 – 06:59	19 (Y) 18:00 – 18:59
8 (N) 07:00 – 07:59	20 (Y) 19:00 – 19:59
9 (N) 08:00 – 08:59	21 (Y) 20:00 – 20:59
10 (N) 09:00 – 09:59	22 (Y) 21:00 – 21:59
11 (N) 10:00 – 10:59	23 (Y) 22:00 – 22:59
12 (Y) 11:00 – 11:59	24 (Y) 23:00 – 23:59
ESC/V/ENTER PAGE UP/DN ↑↓	

OF PERIODS SET IN MEMORY

This is the initial setting of the number of periods

TIME PERIOD

Each Time period can be altered from the defined time ranges providing now two time periods overlap, time periods can also be suppressed from printing.

EMPLOYEE

The employee file contains information for register operators as well as employees who use the register only to clock in or out (employee time keeping.). Specific functions that are allowed or disallowed for each employee are determined by assigning the employee to an authority level.

Two 10 digit code numbers may be assigned for each employee. A time keeping code is used to clock in or out and a separate sign on code used to operate the register. The social security number is for reference only and appears only on reports.

P-MODE PROGRAMMING MENU	L1
1. PLU	
2. PLU STATUS GROUP	
3. GROUP	
4. FUNCTION KEY	
5. SYSTEM OPTION	
6. TAXES	
7. MESSAGES	
8. WINDOW LOOK UP (WLU)	
9. TIME PERIOD	
10. EMPLOYEE	
11. AUTHORITY LEVEL	
12. PRINTER TABLES & KV ROUTING	
▼	ENTER PAGE UP/DN ↑↓

EMPLOYEE# 1 PROGRAMMING	L1
1. NAME	JOHN H
2. SOCIAL SEC #	ABCD00000000
3. CLOCK IN CODE	000000101
4. OPERATING CODE	000000001
5. LINK TO AUTHORITY LEVEL	1
	JOB1 JOB2 JOB3 JOB4 JOB5 JOB6
6. JOB CODE#	01 02 00 00 00 00
7. PAY RATE#	01 02 00 00 00 00
8. OPEN DRAWER# (0-3)	0
9. TRAINING MODE?	N
EDIT JOB CODES ·	
EDIT PAY RATES	
▼	ESC Y/N ENTER PAGE UP/DN ↑↓←→

JOB CODE PROGRAMMING	ALPHA
JOB CODE1	MANAGER
JOB CODE2	WAITRESS
JOB CODE3	BAR STAFF
JOB CODE4	CHEF
JOB CODE5	RECEPTION
JOB CODE6	HOTEL
JOB CODE7	GOLF CLUB
JOB CODE8	POOL
JOB CODE9	ADMISSION
JOB CODE10	HYGEINE
JOB CODE11	KITCHEN
JOB CODE12	JOB#12
▼	ESC Y/N ENTER PAGE UP/DN ↑↓←→

PAY RATE PROGRAMMING	L1
PAY RATE1	09.00
PAY RATE2	08.00
PAY RATE3	07.00
PAY RATE4	06.00
PAY RATE5	05.00
PAY RATE6	04.00
PAY RATE7	03.60
PAY RATE8	05.10
PAY RATE9	05.20
PAY RATE10	05.30
PAY RATE11	05.40
PAY RATE11	00.00
▼	ESC Y/N ENTER PAGE UP/DN ↑↓←→

EMPLOYEE - DEFINITIONS

EMPLOYEE #

This is the sequential program code held by the system

NAME

This is the clerk name entry field

SOCIAL SEC #

This is a reference field for storing the employees official reference number

CLOCK IN CODE

This is the code used for time in/out wages calculations

OPERATING CODE

This is the code used for registration procedures.

LINK TO AUTHORITY LEVEL

Each employee can be linked to one of nine different security levels, defined by the authority program

JOB CODE 1 - 6

Each employee can perform up to six different jobs from waitress to bar manger. This code number is the reference number from the Job code file for the relevant job description

PAY RATE 1 - 6

Each of the six jobs being performed can be allocated from the pay rate table a different hourly rate, which is used for wages calculations

OPEN DRAWER #

This is the cash drawer, which the operator will be using

TRAINING MODE?

Training mode can be accessed via X-mode and appllicable to the whole machine or can be defined for one employee

JOB CODE PROGRAM

Job codes are used to break down the hours worked for all employees into different categories
A breakdown of hours by job is also reported for each employee (The job codes to be used by all employees are set up here. There are 20 possible job codes. Each job code you wish to activate must be given a descriptor here.

PAY RATE PROGRAM

The pay rates to be used by all employees are set up here. There are 50 pay rates., each job code for each employee can be allocated a different pay rate

AUTHORITY

Each employee must be assigned to one of nine authority levels. The selections made here for each authority level determine the operations that are allowed for each employee. For example, in a restaurant an authority level with the descriptor *kitchen help* could be set to allow only clocking in/out, or an authority level with the descriptor *owner* could be set up to allow all functions. Other authority levels could be defined for servers, cashiers and managers that allow only the appropriate functions.

NOTE: It is recommended when using authority the S-MODE system password is allocated.

P-MODE PROGRAMMING MENU	L1
<ol style="list-style-type: none"> 1. PLU 2. PLU STATUS GROUP 3. GROUP 4. FUNCTION KEY 5. SYSTEM OPTION 6. TAXES 7. MESSAGES 8. WINDOW LOOK UP (WLU) 9. TIME PERIOD 10. EMPLOYEE 11. AUTHORITY LEVEL 12. PRINTER TABLES & KV ROUTING 	
▼	ENTER PAGE UP/DN ↑↓

AUTHORITY LEVEL PROGRAMMING	L1
ALPHA DESCRIPTORS	
AUTHORITY LEVEL : 1 23 4 567 89	
<ol style="list-style-type: none"> 1. CLOCK-IN/OUT ENTRY ONLY? <input checked="" type="checkbox"/> NNNNNNNNN 2. MUST CLOCK-IN BEFORE SALES? NNNNNNNNN 3. CAN CLOCK-OUT IF OPEN CHKS? NNNNNNNNN 4. GUEST CHECK ENTRIES ONLY? NNNNNNNNN 5. GUEST# ENTRY ON NEW CHECKS? NNNNNNNNN 6. PAYMENT OF OWN GUEST CHECK? NNNNNNNNN 7. PAYMENT OF ANY GUEST CHECK? Y YYYY YYYY 8. TRANSFER OF GUEST CHECKS? Y YYYY YYYY 9. VOIDING OF SERVICED ITEMS? Y YYYY YYYY 	
▼	ESC Y/N ENTER PAGE UP/DN ↑↓←→

AUTHORITY – DEFINITIONS

LEVEL 1 - 9 DESCRIPTORS

Each of the authority levels can be given a description for reference purposes.

CLOCK-IN/OUT ENTRY ONLY

This allows an employee solely to use the time clock feature

MUST CLOCK-IN BEFORE SALES

This forces an employee to clock in before any register sales can be made.

CAN CLOCK-OUT IF OPEN CHKS

This controls whether an employee can close a session with outstanding balances allocated to themselves still on a check.

GUEST CHECK ENTRIES ONLY

This provides a restriction on employees allowing them only to operate the check tracking system

GUEST# ENTRY ON NEW CHECKS

This forces the entry of a guest number on new checks

PAYMENT OF OWN GUEST CHECK

This provides restriction allowing employees only to receive payment of checks opened by them

PAYMENT OF ANY GUEST CHECK

This provides restriction allowing employees only to receive payment of any checks opened

TRANSFER OF GUEST CHECKS

This provides a restriction for the transfer of check details between employees

VOIDING OF SERVICED ITEMS

This allows control of voids within a check tracking system

ALLOW CANCEL AFTER RECALL

This allows an employee to use cancel with checks and clerk interrupt sales the currently entered sale

CLOCK IN/OUT USING MCR

Determines whether time in/out can be carried out using the MCR (Magnetic Card Reader)

SIGN IN/OUT USING MCR

Determines whether employee sign on can be carried out using the MCR (Magnetic Card Reader)

AUTHORITY – DEFINITIONS

ALLOW EDIT ANY CHECKS

This allows the employee access to any open checks with no restriction to just those opened exclusively by that employee

ALLOW DESTINATION CHANGE

This allows the transfer of checks, movement of check numbers

CAN COMBINE OWN SOFT CHKS

This controls the add check feature, allowing the operator to add their own checks for payment

CAN COMBINE ANY SOFT CHKS

This controls access to the add check feature, allowing the operator to add any checks for payment

TABLE # TRANSFER IN R-MODE

This controls whether it is possible to change the allocated table number within the register mode

CAN PLU PRC/HALO OVERRIDE

This controls whether the pre-set prices and maximum limits of the items can be overridden

ALLOW SET DATE AND TIME

This controls access to the X mode date and time programming option

ALLOW TIME CLOCK EDIT

This control access to the X mode time in/out information edit option

ALLOW CASH DECLARATION

This controls access to the X mode cash declaration option

ALLOW K/B AND PRICE LEVEL

This determines whether the user can change the price level the system is operating, also the ability to change product keyboard menu levels.

ALLOW EMPLOYEE FILE EDIT

The programming of the employee file can be restricted

ALLOW PRINT & RESET OF E.J.

This provides control for the electronic journal reporting

AUTHORITY – DEFINITIONS

ALLOW JOB CODE EDIT

This provides control over employee labour job description programming and amendments

ALLOW PAY RATE EDIT

This provides control over employee labour hourly pay rate programming and amendments

CAN INVENTORY EDIT X MODE

This provides control over as to where the inventory stock can be accessed for amendments

CAN INVENTORY EDIT P MODE

This provides control over as to where the inventory stock can be accessed for amendments

COMP. SEAT# FOR EACH ENTRY

This forces a seat number to be entered for all check sales, for the breakdown of the products sold within the check for payment of the items per seat at final payment

ENABLE TRAINING MODE

Access to the X mode training option can be restricted

ALLOW WLU FILE EDIT

This allows restriction to the Window Look Unit menu programming

ALLOW NO SALE

This provides restriction for the no sale function operation

PAID BREAKS

This determines whether when an employee has clock out for a break whether time is paid as part of wage costing.

MANAGER REQ. FOR CLOCK IN

This only allows clock in to take place in the X Manager Control mode.

COMPULSORY TIP ENTRY

This forces the operator to enter a tip amount as they clock out of the system

JOB CODE CHANGE

This controls whether an employee is allowed to change the designated job description and allocated pay rate

ALLOW PLU PRC CHANGE ONLY

The program mode can be restricted so the operator can only program product prices

PRINTER TABLES AND KV ROUTING

The printing system of an *SPS 1000* register or system of registers is completely flexible. Up to 40 printers can be defined and connected to any available serial port on any register within a system. Multiple printer functions can be assigned to the same printer, giving added flexibility. Before programming here, you must

- See "Serial Port Device Selections" in S-Mode Programming to define the type of device that is connected
- See "Define Serial Port Parameters" in S-Mode Programming to match the baud rate/parity/etc. between the serial port and the printer. This program also controls the feed lines before and after printing, the logo size, and cutting options.
- See "Printer Driver Selections" if you are using a printer other than the printers with predefined drivers, or if you need to customize a driver for a printer.
- Next, assign a port for each printer, assign printer number (1-40), give it a 10 character descriptor (i.e. salad prep, receipt, or detail) and identify the port # and the register # to which it is attached. In addition, you can identify a back-up location for information designated to go to the printer.
- Finally, proceed with the parts of this program that pertain to your application:
- Because it is sometimes necessary to change kitchen printer routing depending upon the time of the day, (for example, separate hot and cold food kitchens may be active during lunch and a single kitchen active during dinner) you can make assignments for four different periods. The active routing period can be controlled automatically Routing can also be allocated to be activated centrally using one master terminal or each terminal independent

P-MODE PROGRAMMING MENU	L1
<ol style="list-style-type: none"> 1. PLU 2. PLU STATUS GROUP 3. GROUP 4. FUNCTION KEY 5. SYSTEM OPTION 6. TAXES 7. MESSAGES 8. WINDOW LOOK UP (WLU) 9. TIME PERIOD 10. EMPLOYEE 11. AUTHORITY LEVEL 12. PRINTER TABLES & KV ROUTING 	
▼	ENTER PAGE UP/DN ↑↓

PRINTER & KV ROUTING MENU	L1	
<table border="1" style="margin: 10px auto;"> <tr> <td> <ol style="list-style-type: none"> 1. SYSTEM PRINTER CONFIGURATION 2. KITCHEN VIDEO ROUTING 3. KITCHEN PRINTER ROUTING 4. RECEIPT PRINTER ROUTING 5. DETAIL PRINTER ROUTING </td> </tr> </table>	<ol style="list-style-type: none"> 1. SYSTEM PRINTER CONFIGURATION 2. KITCHEN VIDEO ROUTING 3. KITCHEN PRINTER ROUTING 4. RECEIPT PRINTER ROUTING 5. DETAIL PRINTER ROUTING 	
<ol style="list-style-type: none"> 1. SYSTEM PRINTER CONFIGURATION 2. KITCHEN VIDEO ROUTING 3. KITCHEN PRINTER ROUTING 4. RECEIPT PRINTER ROUTING 5. DETAIL PRINTER ROUTING 		
FSC ENTER PAGE UP/DN ↑↓		

SYSTEM PRINTER CONFIGURATION

Every printer used within the system must be allocated a printer number within this menu option

KITCHEN VIDEO ROUTING

The video display system must be activate within this menu option

KITCHEN PRINTER ROUTING

Each route required for printing must be allocated a printer number within this menu option

RECEIPT PRINTER ROUTING

Each receipt printer within the system must be allocated within this menu option

DETAIL PRINTER ROUTING

Each detailed journal printer within the system must be allocated within this menu option

SYSTEM PRINTER CONFIGURATION

Used to assign a port for each printer. Then assign printer number (1-40), give it a 10 character descriptor (i.e. salad prep, receipt, or detail) and identify the port # and the register # to which it is attached. In addition, you can identify a back-up location for information designated to go to the printer. (For example, if the salad printer is not functioning, then could be sent to a different printer.)

SYSTEM PRINTER CONFIGURATION		ALPHA	
		MAIN	BACKUP
PRINTER #	DESCRIPTOR	REG#-PORT#	REG#-PORT#
# 1	RCPT TILL1	01-2	02-2
# 2	DETL TILL1	01-1	02-1
# 3	RCPT TILL2	02-2	01-2
# 4	DETL TILL2	02-1	01-1
# 5	KITCHEN 1	02-1	00-0
# 6		00-0	00-0
# 7		00-0	00-0
# 8		00-0	00-0
# 9		00-0	00-0
#10		00-0	00-0

▼ ESC V/N ENTER PAGE UP/DN ↑.]

PRINTER NO.

This is a sequential number generated by the system that will be used to refer to the printer throughout the system

DESCRIPTOR

This is a description of the task the printer will be carrying out i.e. Receipt-till 1, KP-till 2

REG#-PORT# MAIN

This is the register number and the physical port number on that register the printer is connected to. This is the MAIN output which will be used under normal circumstances

REG#-PORT# BACKUP

This is the register number and the physical port number on that register the printer is connected to. This is the Backup output which will be used when there is no access to the normal route

KITCHEN VIDEO ROUTING

Use Kitchen Video Routing to define the location of the video controller. If you wish to designate a backup printer, in the event that the video system is not operational, enter the location of the back-up here.

KITCHEN VIDEO ROUTING			ALPHA
VIDEO#	DESCRIPTOR	MAIN REG#-PORT#	BACKUP PRINTER#
#1	VIDEO 1	01-2	00

ESC Y/N ENTER PAGE UP/DN ↑↓←→

VIDEO

This is a sequential number generated by the system that will be used to refer to the video throughout the system

DESCRIPTOR

This is a description of the task the video will be carrying out i.e. Main Bar 1, Kitchen 2.

REG#-PORT# MAIN

This is the register number and the physical port number on the register that the video is connected to. This is the MAIN output, which will be used under normal circumstances

PRINTER# BACKUP

This is the system printer number(0 - 40) on the register. This is the Backup output, which will be used when there is no access to the normal route

RECEIPT PRINTER ROUTING

This controls the routing of the receipt printer, defining which terminal the printer is connected to, this is master list for the whole of the network.

RECEIPT PRINTER ROUTING				L1
REGISTER#	PRINTER#	REGISTER#	PRINTER#	
01	01	00	00	
02	02	00	00	
00	00	00	00	
00	00	00	00	
00	00	00	00	
00	00	00	00	
00	00	00	00	
00	00	00	00	
00	00	00	00	
00	00	00	00	
00	00	00	00	

▼ ESC V/ENTERED PAGE UP/DN ↑ ↓ ↵

REGISTER

This is the register number that requires a receipt printer, all registers must be allocated within this section

PRINTER

This is the printer number allocated in system printer configuration that is to be used. The information will then be routed down the channel which was configured in that section

DETAIL PRINTER ROUTING

This controls the routing of the journal printer defining which terminal the printer is connected to. This is a master list for the whole of the network.

DETAIL PRINTER ROUTING				L1
REGISTER#	PRINTER#	REGISTER#	PRINTER#	
01	01	00	00	
02	02	00	00	
00	00	00	00	
00	00	00	00	
00	00	00	00	
00	00	00	00	
00	00	00	00	
00	00	00	00	
00	00	00	00	
00	00	00	00	
00	00	00	00	

▼ ESC V/MENTED PAGE UP/DN ↑ ↓ ↵

REGISTER

This is the register number that requires a detailed journal printer, all registers must be allocated within this section

PRINTER

This is the printer number allocated in system printer configuration that is to be used. The information will then be routed down the channel which was configured in that section

INGREDIENT INVENTORY

A *menu-explosion type inventory system* is set up when PLUs are linked to a Recipe# and recipes are then programmed with a list of ingredients. Use X-MODE MANAGER MENU to receive, transfer in/out, or enter raw waste for ingredients in this system.

NOTE: Be careful not to confuse the separate and distinct inventory features

- Recipes and Ingredients – Stock control of components making up a saleable product
- Product Mix Groups usage analysis of a group of saleable products
- PLU Stock – Stock control of saleable products

P-MODE PROGRAMMING MENU	L1
13. INGREDIENT INVENTORY	
14. TIME ACTIVATED FUNCTIONS	
15. PRODUCT MIX GROUPS	
16. MIX & MATCH TABLE	
17. CUSTOM REPORT	
18. STRING REPORT	
19. PLU STOCK	
20. PLU MINIMUM STOCK	
21. COPY PROGRAM	
22. PROGRAM FILE DOWNLOAD	
23. P-MODE PROGRAM SCAN PRINTING	
24. NON-PLU CODE	
◆	ENTER PAGE UP/DN ↑↓

INGREDIENT INVENTORY MENU	L1
1. EDIT INGREDIENT 2. RECEIPT TABLE	
ESC ENTER PAGE UP/DN ↑↓	

INGREDIENT PROGRAMMING		ALPHA
INGREDIENT#	DESCRIPTOR	COST
001	BURGER	000.120
002	BREAD BUN	000.060
003	RELISH PACK	000.100
004		000.000
005		000.000
006		000.000
007		000.000
008		000.000
009		000.000
010		000.000
▼		ESC Y/N ENTER PAGE UP/DN ↑↓←→

RECIPE# 1 PROGRAMMING		ALPHA
DESCRIPTOR	ING/RECIPE	#
		BURGER&SALAD
		DESCRIPTOR QTY
01	INGREDIENT	01 BURGER 002
02	INGREDIENT	02 BREAD BUN 001
03	RECIPE	04 SIDE SALAD 001
04	INGREDIENT	00 000
05	INGREDIENT	00 000
06	INGREDIENT	00 000
07	INGREDIENT	00 000
08	INGREDIENT	00 000
09	INGREDIENT	00 000
10	INGREDIENT	00 000
▼		ESC Y/N ENTER PAGE UP/DN ↑↓←→

INGREDIENT – DEFINITIONS

It is possible to program a list of ingredients, which can then be linked to create a recipe. This recipe is then allocated to a PLU number. This ensures that when the PLU is sold, the stock is deducted from the relevant ingredients by the appropriate quantities

EDIT INGREDIENT

This is where all the ingredients are allocated. These ingredients are independent of the PLU file

INGREDIENT #

The first section is the sequential ingredient reference number

DESCRIPTOR

This is the description of the ingredient

COST

This is the cost of the ingredient to the smallest possible usage i.e. gram, etc. that will be required within a recipe you would enter 8 for a 1/2lb steak.

RECIPE TABLE

It is possible to link ingredients together to form a complete menu. Recipes can also be linked to other recipes to form a more comprehensive inventory. i.e. side salad recipe can be linked to steak recipe

NUMBER

The first section is the sequential recipe reference number

ING/RECIPE

This indicates whether the item to be entered is from the ingredient file or is already created as recipe ready to be included into this recipe

#

This is either the ingredient number or the recipe number depending on the ING/RECIPE answer, Pressing DONE here will provide a list of either ingredients or recipes for selection

DESCRIPTOR

This automatically displays the description related to the code number entered as an ingredient

QTY

This is the quantity of the ingredient to be updated when the relevant PLU linked to this recipe is sold. Ingredients should be programmed in the lowest possible usage i.e. grams and this quantity used to allocate the number of small components i.e. 10 grams

TIME ACTIVATED PROGRAM

It is possible to automate a number of functions in order to provide a complete system management, levels can be changed, reports run, printer re-routed etc..

P-MODE PROGRAMMING MENU	L1
13. INGREDIENT INVENTORY	
14. TIME ACTIVATED FUNCTIONS	
15. PRODUCT MIX GROUPS	
16. MIX & MATCH TABLE	
17. CUSTOM REPORT	
18. STRING REPORT	
19. PLU STOCK	
20. PLU MINIMUM STOCK	
21. COPY PROGRAM	
22. PROGRAM FILE DOWNLOAD	
23. P-MODE PROGRAM SCAN PRINTING	
24. NON-PLU CODE	
◆	ENTER PAGE UP/DN ↑↓

TIME ACTIVATED FUNCTIONS MENU	L1
1. KEYBOARD LEVELS	
2. PRICE LEVELS	
3. MACROS	
4. STRING REPORTS	
5. SHIFTS	
6. KP TIME PERIOD	
	ESC ENTER PAGE UP/DN ↑↓

TIME ACTIVATED – KEYBOARD LEVELS

This automates the change of menu level keys at specific times, on specific days, reverting back when the next keyboard level is timed to commence.

TIME ACTIVATE KEYBOARD LEVEL#1	L1
ACTIVATE AT (99:99 = DISABLED)	99:99
WEEK : SUN MON TUE WED THU FRI SAT	
Y Y Y Y Y Y Y	
ESC Y/N ENTER PAGE UP/DN ↑↓←→	

KEYBOARD LEVEL

This switches the default keyboard level to that selected

LEVEL #

This is the keyboard level 1 - 5 that is to be automated

ACTIVATE AT (99:99 = DISABLED)

This is the time when the menu level is to switch from default to the LEVEL# no end time is required and the switch back again will also be programmed as an activated time change

WEEK : SUN ETC.

Days of the week can be included and excluded as required from this menu switch

TIME ACTIVATED – PRICE LEVELS

This automates the change to any of the twenty ‘*price sets*’ at specific times, on specific days, reverting back when the next price level is timed to commence.

TIME ACTIVATE PRICE LEVEL# 1	L1
ACTIVATE AT (99:99 = DISABLED)	99:99
WEEK : SUN MON TUE WED THU FRI SAT	
Y Y Y Y Y Y Y	
ESC Y/N ENTER PAGE UP/DN ↑↓←→	

PRICE LEVEL

This switches the default price level to that selected

LEVEL #

This is the price level 1 - 20 that is to be automated

ACTIVATE AT (99:99 = DISABLED)

This is the time when the price level is to switch from default to the PRICE LEVEL# no end time is required and the switch back again will also be programmed as an activated time change

WEEK : SUN ETC.

Days of the week can be included and excluded as required from price switch

TIME ACTIVATED – MACRO KEYS

This automates, the macro keys which in turn run a sequence of function key presses. These run at specific times on specific days, reverting back when the next keyboard level is times to commence.

NOTE: When using automated key macros it is advisable to ensure that the P-mode system flag which prevents macros running in a continuous loop is turned on.

TIME ACTIVATE MACRO# 1	L1
ACTIVATE AT (99:99 = DISABLED)	99:99
REPEAT EVERY MINUTES(0 = NO REPEAT) 000	
WEEK : SUN MON TUE WED THU FRI SAT	
Y Y Y Y Y Y Y	
ESC Y/N ENTER PAGE UP/DN ↑↓←→	

MACROS

There are pre-programmed key sequences stored as macro, the automation will activate the sequence allocated to the macro key 1 - 40 that is selected.

MACRO#

This is the macro key number to be automated

ACTIVATE AT (99:99 = DISABLED)

This is the time when the function is to be activated

REPEAT EVERY MINUTES (0 = NO REPEAT)

It is possible to repeat the function every few minutes. This form a continuous loop, it is therefore imperative you are aware of the actions to be carried out.

WEEK : SUN ETC.

Days of the week can be included and excluded as required from this automation

TIME ACTIVATED – STRING REPORTS

This automates the reporting, running a pre-designed collection of reports at specific times, on specific days.

TIME ACTIVATE STRING REPORT#1	L1
ACTIVATE AT (99:99 = DISABLED)	99:99
REPEAT EVERY MINUTES (0 = NO REPEAT) 000	
WEEK : SUN MON TUE WED THU FRI SAT	
Y Y Y Y Y Y Y	
IRC OPTION :	STANDALONE
REG# ISSUES IRC STRING REPORT	00
ESC Y/N ENTER PAGE UP/DN ↑↓←→	

STRING REPORTS

It is possible to timed reports by combining the relevant reports and selecting a report type in the string report programming

STRING REPORT#

This is the report number to be automated

ACTIVATE AT (99:99 = DISABLED)

This is the time when the report is to be activated

REPEAT EVERY MINUTES (0 = NO REPEAT)

It is possible to repeat the function every few minutes. This form a continuous loop, it is therefore imperative you are aware of the actions to be carried out.

WEEK : SUN ETC.,

Days of the week can be included and excluded as required from this automation

TIME ACTIVATED – SHIFTS

This automates the switch to the next shift reporting period, commencing a new report this happens at up to four specific times per day.

SHIFT TIME PROGRAMMING		ALPHA
SHIFT	DESCRIPTOR	START/END TIME
1	MORNING	09:00 – 10:59
2	LUNCH	11:00 – 12:59
3	AFTERNOON	13:00 – 15:59
4	EVENING	16:00 – 23:00
TTL		

ESC Y/N ENTER PAGE UP/DN ↑↓←→

SHIFT

The system has a shift report comprising of 4 shifts. A new shift can be activated manually or automated. This will start a new period of financial storage.

DESCRIPTOR

This is enables a name to be allocated to each shift.

START TIME FOR EACH OF THE FOUR PERIODS

This is the time the shift commences

END TIME FOR EACH OF THE FOUR PERIODS

This is the time the shift ends

TIME ACTIVATED – KITCHEN PRINTING

Because it is sometimes necessary to change kitchen printer routing depending upon the time of the day, (for example, separate hot and cold food kitchens may be active during lunch and a single kitchen active during dinner) you can make assignments for four different periods. The active routing period can be controlled automatically. Routing can also be allocated to be activated centrally using one master terminal or each terminal independent. If kitchen printing changes are not required to be timed, the routing can be changed in register using either one of the three analysis keys or the KP routing key.

KP TIME PERIOD PROGRAMMING		L1
PERIOD	START/END TIME	
-----	-----	
1	09:00 – 10:59	
2	11:00 – 12:59	
3	13:00 – 15:59	
4	16:00 – 23:00	

ESC Y/N ENTER PAGE UP/DN ↑↓←→

KP TIME PERIOD

It is possible to switch what kitchen printers are in use, and change the routing of products depending on the time of day. The four periods are allocated in printer programming with the appropriate printers and then the following automation can be programmed

START TIME FOR EACH OF THE FOUR PERIODS

This is the time the switch to a different kitchen period will change

END TIME FOR EACH OF THE FOUR PERIODS

This is the time the switch to the new range of kitchen printer will end.

PRODUCT MIX GROUPS PROGRAM

Product mix groups can be used to program each product with a piece count usage of a case, with the product group defining how many units are in each outer. This will then provide reporting on how many units and case have been used per group, per time period with option seven day, four week projections

NOTE: Be careful not to confuse the separate and distinct inventory features of the SPS 1000:

- Recipes and Ingredients – Stock control of components making up a saleable product
- Product Mix Groups usage analysis of a group of saleable products
- PLU Stock – Stock control of saleable products

P-MODE PROGRAMMING MENU		L1
13. INGREDIENT INVENTORY		
14. TIME ACTIVATED FUNCTIONS		
15. PRODUCT MIX GROUPS		
16. MIX & MATCH TABLE		
17. CUSTOM REPORT		
18. STRING REPORT		
19. PLU STOCK		
20. PLU MINIMUM STOCK		
21. COPY PROGRAM		
22. PROGRAM FILE DOWNLOAD		
23. P-MODE PROGRAM SCAN PRINTING		
24. NON-PLU CODE		
◆ ENTER PAGE UP/DN ↑↓		

PRODUCT MIX GROUPS MENU		L1
1. PRODUCT MIX ITEMS 2. PRODUCT MIX GROUP TIME PERIODS		
ESC ENTER PAGE UP/DN ↑↓		

PRODUCT MIX ITEM PROGRAMMING ALPHA			
ITEM#	DESCRIPTOR	PCS/UNIT	UNIT DESC
001	BRANDY	032	BOTT
002	TETLEY DRAUG	016	1 / 2s
003	BOT BECKS	024	CASE
004		000	
005		000	
006		000	
007		000	
008		000	
009		000	
010		000	
▼ ESC Y/N ENTER PAGE UP/DN ↑↓←→			

PRODUCT MIX TIME PERIOD PROGRAMMING L1			
# OF PERIODS SET IN MEMORY : 24			
1	(Y)	00:00 – 00:59	13 (Y) 12:00 – 12:59
2	(Y)	01:00 – 01:59	14 (Y) 13:00 – 13:59
3	(Y)	02:00 – 02:59	15 (Y) 14:00 – 14:59
4	(N)	03:00 – 03:59	16 (Y) 15:00 – 15:59
5	(N)	04:00 – 04:59	17 (Y) 16:00 – 16:59
6	(N)	05:00 – 05:59	18 (Y) 17:00 – 17:59
7	(N)	06:00 – 06:59	19 (Y) 18:00 – 18:59
8	(N)	07:00 – 07:59	20 (Y) 19:00 – 19:59
9	(N)	08:00 – 08:59	21 (Y) 20:00 – 20:59
10	(N)	09:00 – 09:59	22 (Y) 21:00 – 21:59
11	(N)	10:00 – 10:59	23 (Y) 22:00 – 22:59
12	(N)	11:00 – 11:59	24 (Y) 23:00 – 23:59
ESC Y/N ENTER PAGE UP/DN ↑↓←→			

PRODUCT MIX GROUPS– DEFINITIONS

Product mix groups are used to track the usage of specific items in addition to the major groups. There is also reporting information provided by the product mix groups that is superior to other group reporting. With product mix groups, you can also assign a piece count / inventory usage values to each PLU. This ensures when a product is sold, the product mix group is updated with the appropriate quantity in the piece count. This usage information is used to provide hourly inventory usage of selected products, also providing the memory allocation has been set with the projection on.

PRODUCT MIX GROUPS

ITEM#

This is a sequential product mix group number

DESCRIPTOR

This is description of the item to be tracked i.e. beef burgers

PCS/UNIT

This is the number of items in a case i.e. 12 burgers per case

UNIT DESC

This is the description of the case i.e. 12 Burgers are a DOZEN

RELEVANT PLU PROGRAMMING

PIECE COUNT

This is the number of items used from the product group pack i.e. the number of bottles in a case, the number of burgers in a box

PRODUCT MIX#

This is the link to group i.e. all PLUs using burgers would be linked to the product mix group, or a group would be set for each type of bottle beer.

PRODUCT MIX TIME PERIOD

Memory allocation determines whether there are 24-Hourly, 48-Half Hourly or 96 - 15mins product mix time periods. Periods can be set to custom lengths using the program. If fewer periods are needed than are available, then the unused deactivated, using the Y/N toggle.

MIX & MATCH TABLE PROGRAM

This is used to automate promotional discounts, each table is linked to one or many PLU items activating such features as 'buy one get one free' etc...

P-MODE PROGRAMMING MENU	L1
13. INGREDIENT INVENTORY	
14. TIME ACTIVATED FUNCTIONS	
15. PRODUCT MIX GROUPS	
16. MIX & MATCH TABLE	
17. CUSTOM REPORT	
18. STRING REPORT	
19. PLU STOCK	
20. PLU MINIMUM STOCK	
21. COPY PROGRAM	
22. PROGRAM FILE DOWNLOAD	
23. P-MODE PROGRAM SCAN PRINTING	
24. NON-PLU CODE	
◆	ENTER PAGE UP/DN ↑↓

MIX & MATCH TABLE PROGRAMMING ALPHA			
TBL#	DESCRIPTOR	TRIP LVL	PRICE
001	BUY 1 GET 1	01	000001.99
002	DISCOUNT#2	00	000000.00
003	DISCOUNT#3	00	000000.00
004	DISCOUNT#4	00	000000.00
005	DISCOUNT#5	00	000000.00
006	DISCOUNT#6	00	000000.00
007	DISCOUNT#7	00	000000.00
008	DISCOUNT#8	00	000000.00
009	DISCOUNT#9	00	000000.00
010	DISCOUNT#10	00	000000.00
▼	ESC Y/N ENTER PAGE UP/DN ↑↓		

TBL#

This is the mix and match table number, this will be allocated to the PLU products to activate the discount

DESCRIPTOR

This is the discount description that will be printed on the sales receipts, indicating the reason for the discount i.e. 2 for 1, or Buy one get one free

TRIP LVL

This is the number of PLU products allocated to this table this must be sold before the discount is given

PRICE

This is the value of money to be discounted from the sales total

CUSTOM REPORT

CUSTOM REPORTS PROGRAMMING

One custom report can be created, with up to 50 totals and counters. The report is built by selecting totals that also appear on other register reports. When the custom report is created, totals and counters separate from the original report are also created (in other words, you can clear either the custom independently without affecting totals in any other report.)

Another feature of the custom report is the ability to add or subtract selected totals to create a new subtotal of selected information.

P-MODE PROGRAMMING MENU	L1
13. INGREDIENT INVENTORY	
14. TIME ACTIVATED FUNCTIONS	
15. PRODUCT MIX GROUPS	
16. MIX & MATCH TABLE	
17. CUSTOM REPORT	
18. STRING REPORT	
19. PLU STOCK	
20. PLU MINIMUM STOCK	
21. COPY PROGRAM	
22. PROGRAM FILE DOWNLOAD	
23. P-MODE PROGRAM SCAN PRINTING	
24. NON-PLU CODE	
◆	ENTER PAGE UP/DN ↑↓

REPORT PROGRAMMING	L1
1. CUSTOM REPORT 2. EDIT EXISTING REPORTS	
ENTER PAGE UP/DN ↑↓	

CUSTOM REPORT PROGRAMMING						L1
RPT TTL						
#	#	#	RED	+/-	DESCRIPTOR	
01	1	001	N	+(ADD)	+PLU LVL1 TTL	
02	1	003	N	+(ADD)	+PLU LVL2 TTL	
03	0	998	N	NONADD	(DASHIED LINE)	
04	0	999	N	NONADD	PLU TOTAL	
05	0	000	N	NONADD		
06	0	000	N	NONADD		
07	0	000	N	NONADD		
08	0	000	N	NONADD		
09	0	000	N	NONADD		
10	0	000	N	NONADD		
▼ DONE:LIST ESC ENT PAGE UP/DN ↑↓←→						

CUSTOM REPORT - DEFINITIONS

RPT#

This is the report number to be used. The report numbers can be found on the X/Z menus

TTL#

This is the totaliser from the report i.e. Report 1 financial total 1 (line 1) +PLU LVL 1 TTL
999 - Provides a custom subtotal line 998 - Prints a dashed line separator

RED

Print in RED providing the printer has red black capabilities

+ / -

This is used to indicate if the total on this line is to be added or subtracted to create a new subtotal. When the TTL# code i.e. 999 is entered on a later line. Previous totals with are + / - designation are added and printed. 998 Prints a dashed lined across the report.

DESCRIPTOR

This is the default description of the totaliser selected, this can be changed if required

Note: Use the total #998 to create a dashed separator line on the report.
Use the total #999 to create a subtotal line.

The subtotal line will calculate the totals designated "+" or "-" that appear sequentially after the previous subtotal line. Enter a custom descriptor for the subtotal line.

CUSTOM REPORT – EDIT EXISTING REPORTS

EDIT EXISTING REPORTS

It is possible to determine whether information is printed in black or printed in red on existing financial and employee reports. This works in-conjunction with the zero skip system flag.

P-MODE PROGRAMMING MENU	L1
13. INGREDIENT INVENTORY	
14. TIME ACTIVATED FUNCTIONS	
15. PRODUCT MIX GROUPS	
16. MIX & MATCH TABLE	
17. CUSTOM REPORT	
18. STRING REPORT	
19. PLU STOCK	
20. PLU MINIMUM STOCK	
21. COPY PROGRAM	
22. PROGRAM FILE DOWNLOAD	
23. P-MODE PROGRAM SCAN PRINTING	
24. NON-PLU CODE	
◆	ENTER PAGE UP/DN ↑↓

REPORT PROGRAM	L1
1. CUSTOM REPORT 2. EDIT EXISTING REPORTS	
↓	
1. FINANCIAL REPORT 2. EMPLOYEE REPORT	
ESC ENTER PAGE UP/DN ↑↓	

EDIT FINANCIAL REPORT				L1
TTL#	DESCRIPTOR	PRINT?	RED?	
001	+PLU LVL1 TTL		Y	
N				
002	-PLU LVL1 TTL	Y	N	
003	+PLU LVL2 TTL		Y	
N				
004	-PLU LVL2 TTL	Y	N	
005	+PLU LVL3 TTL		Y	
N				
006	-PLU LVL3 TTL	Y	N	
007	+PLU LVL4 TTL		Y	
N				
008	-PLU LVL4 TTL	Y	N	

PRINT ?

This determines if the field will be printed on the report it is a Yes / No option

RED ?

This determines whether the field will print RED (providing the printer has Red/Black capabilities)

STRING REPORT

It is possible to group reports together so that all information is printed at once when the design report is selected from the reporting menu.

P-MODE PROGRAMMING MENU		L1
13.	INGREDIENT INVENTORY	
14.	TIME ACTIVATED FUNCTIONS	
15.	PRODUCT MIX GROUPS	
16.	MIX & MATCH TABLE	
17.	CUSTOM REPORT	
18.	STRING REPORT	
19.	PLU STOCK	
20.	PLU MINIMUM STOCK	
21.	COPY PROGRAM	
22.	PROGRAM FILE DOWNLOAD	
23.	P-MODE PROGRAM SCAN PRINTING	
24.	NON-PLU CODE	
◆	ENTER PAGE UP/DN ↑↓	

STRING REPORT#1 PROGRAMMING					L1
DESCRIPTOR		STRING REPORT #1			
RPT LVL					
#	X/Z	(1 - 5)	RPT#	DESCRIPTOR	
01	Z	2	01	FINANCIAL	
02	Z	2	02	SALES BY TIME	
03	X	0	00		
04	X	0	00		
05	X	0	00		
06	X	0	00		
07	X	0	00		
08	X	0	00		
09	X	0	00		
10	X	0	00		
▼	FSC Y/N ENTER PAGE UP/DN ↑↓←→				

STRING REPORT - DEFINITIONS

STRING REPORT #

This is the number of the report to be programmed

X/Z

This determines what type of report is to be printed X - Read, Z-Reset or current, depending on the position of the mode lock at that time.

RPT LEVEL

This relates to the reporting area any one of the five can be selected for reporting

RPT#

This is the report number to be printed

DESCRIPTOR

This is the name of the report to be printed

PLU STOCK ENTRY

PLU stock is a simple inventory system where each whole unit PLU activity subtracts a value of "1" from the stock counter. The quantity modifier and stock link PLU programming can be used to link together two products so stock is reduced from one item with decimal quantity reduction if required.

PLU stock applies only to PLUs that are assigned to a PLU status group with the Stock PLU? setting set to Y Select PLU STOCK to maintain stock levels on PLUs selected for stock unit inventory.

NOTE: Be careful not to confuse the separate and distinct inventory features

- Recipes and Ingredients – Stock control of components making up a saleable product
- Product Mix Groups usage analysis of a group of saleable products
- PLU Stock – Stock control of saleable products

P-MODE PROGRAMMING MENU	L1
13. INGREDIENT INVENTORY 14. TIME ACTIVATED FUNCTIONS 15. PRODUCT MIX GROUPS 16. MIX & MATCH TABLE 17. CUSTOM REPORT 18. STRING REPORT 19. PLU STOCK 20. PLU MINIMUM STOCK 21. COPY PROGRAM 22. PROGRAM FILE DOWNLOAD 23. P-MODE PROGRAM SCAN PRINTING 24. NON-PLU CODE	
◆	ENTER PAGE UP/DN ↑↓

PLU STOCK MENU	L1	
<table border="1"> <tr> <td> 1. ADD 2. OVERRIDE 3. SUBTRACT </td> </tr> </table>		1. ADD 2. OVERRIDE 3. SUBTRACT
1. ADD 2. OVERRIDE 3. SUBTRACT		
ESC ENTER PAGE UP/DN ↑↓		

PLU#000000000000000000 STOCK(ADD)	
•PRESS THE PLU TO BE PROGRAMMED	
OR	
•ENTER THE PLU NUMBER AND PRESS ENTER	
OR	
•ENTER THE PLU NUMBER AND PRESS PLU#	
PLU# ESC ENTER INDIVIDUAL PLU	

PLU#000000000000000001 STOCK(ADD)	
DESCRIPTOR :	BOTTLE BECKS
STOCK	0.00
PLU# ESC Y/N ENT PAGE UP/DN ↑↓←→	

PLU STOCK ENTRY - DEFINITIONS

PLU STOCK MENU

ADD

This adds to the existing stock figures. Used for deliveries transfers in etc..

SUBTRACT

This subtracts for the existing stock figures, Used for Returns, transfers out etc.

OVERRIDE

This overrides the existing stock figures. Used for beginning inventory etc..

PLU STOCK ENTRY

PLU#

This is the product code number of the item to be allocated a minimum stock

DESCRIPTOR

This is the product description of the item to be allocated a minimum stock

STOCK

This is the current stock situation and the value now to be adjusted

PLU MINIMUM STOCK PROGRAM

Each product which is defined as a 'Stock PLU' can be allocated with a minimum stock figure once the products stock holding falls below this level, the item will then be available for print on the Minimum Stock report. This feature assists with the re-ordering of stock

P-MODE PROGRAMMING MENU	L1
13. INGREDIENT INVENTORY 14. TIME ACTIVATED FUNCTIONS 15. PRODUCT MIX GROUPS 16. MIX & MATCH TABLE 17. CUSTOM REPORT 18. STRING REPORT 19. PLU STOCK 20. PLU MINIMUM STOCK 21. COPY PROGRAM 22. PROGRAM FILE DOWNLOAD 23. P-MODE PROGRAM SCAN PRINTING 24. NON-PLU CODE	
ENTER PAGE UP/DN ↑↓	

PLU#000000000000000000 MIN.STOCK PROGRAM <ul style="list-style-type: none"> •PRESS THE PLU TO BE PROGRAMMED OR •ENTER THE PLU NUMBER AND PRESS ENTER OR •ENTER THE PLU NUMBER AND PRESS PLU# <p style="text-align: center;">PLU# ESC ENTER INDIVIDUAL PLU</p>
--

PLU#000000000000000001 MIN.STOCK PGM DESCRIPTOR : BOTTLE BECKS MINIMUM STOCK 0.00
PLU# ESC Y/N ENT PAGE UP/DN ↑↓←→

PLU#

This is the product code number of the item to be allocated a minimum stock

DESCRIPTOR

This is the product description of the item to be allocated a minimum stock

MINIMUM STOCK

This is quantity of units that are required as a minimum when the value falls below this level the item will be shown on a minimum stock report indicating re-order is required.

COPY PROGRAM

This function allows you to duplicate programs for :

PLUs

PLU Status Groups

Keyboard Levels

WLUs

For example, all program options for one PLU can be duplicated on another PLU.

NOTE: See “If General Function Option “ALLOW PLU COPY BY RANGE” is set to “Y”, then the options from one PLU or PLU Status Group can be copied to a range of PLUs or PLU Status Groups. If the option is set to “N” then the options from an individual PLU or PLU Status Group can be copied only to another individual PLU or PLU Status Group.

P-MODE PROGRAMMING MENU	L1
13. INGREDIENT INVENTORY	
14. TIME ACTIVATED FUNCTIONS	
15. PRODUCT MIX GROUPS	
16. MIX & MATCH TABLE	
17. CUSTOM REPORT	
18. STRING REPORT	
19. PLU STOCK	
20. PLU MINIMUM STOCK	
21. COPY PROGRAM	
22. PROGRAM FILE DOWNLOAD	
23. P-MODE PROGRAM SCAN PRINTING	
24. NON-PLU CODE	
◆	ENTER PAGE UP/DN ↑↓

COPY PROGRAM	L1
1. COPY PLU	
2. COPY PLU STATUS GROUP	
3. COPY KEYBOARD LEVEL	
4. COPY WLU	
FROM PLU # : 0000000000000000	
TO PLU RANGE : 0000000000000000	
- 0000000000000000	
ESC ENTER	

COPY PROGRAM - DEFINITIONS

COPY PLU

Used to copy the information held against an individual PLU to another saving time and energy on repetitive programming. This can be done singularly i.e. one PLU to another or by enabling the system flag PLU copy by range, from one PLU to a range of other PLUS

COPY PLU STATUS GROUP

Used to copy the information held against an individual PLU Program STATUS GROUP to another range of groups. This saves both time and energy on repetitive programming.

COPY KEYBOARD LEVEL

Used to copy the function program and PLU allocation of one keyboard to another. This saves both time and energy on repetitive programming.

COPY WLU (WINDOW LOOK UP)

Used to copy the information held against a menu selection window to another, this saves both time and energy on repetitive programming.

PROGRAM FILE DOWNLOAD

This allows transfer of all of individual files to All, individual, or groups of terminals.

P-MODE PROGRAMMING MENU L1

- 13. INGREDIENT INVENTORY
- 14. TIME ACTIVATED FUNCTIONS
- 15. PRODUCT MIX GROUPS
- 16. MIX & MATCH TABLE
- 17. CUSTOM REPORT
- 18. STRING REPORT
- 19. PLU STOCK
- 20. PLU MINIMUM STOCK
- 21. COPY PROGRAM
- 22. PROGRAM FILE DOWNLOAD**
- 23. P-MODE PROGRAM SCAN PRINTING
- 24. NON-PLU CODE

◆ ENTER PAGE UP/DN ↑↓

PROGRAM FILE DOWNLOAD L1

- 1. ALL FILES**
- 2. SELECT PROGRAM FILES

ESC ENTER PAGE UP/DN ↑↓

DOWNLOADING REGISTER SELECTION L1

1. REGISTER :

**ALL REGISTERS
SELECTED**

ESC Y/N ENT PG UP/DN ↑↓ DONE:DOWN

REGISTER SELECTION: L1

01	02	03	04	05	06	07	08
Y	Y	N	N	N	N	N	N
09	10	11	12	13	14	15	16
Y	Y	N	N	N	N	N	N
17	18	19	20	21	22	23	24
Y	Y	N	N	N	N	N	N
25	26	27	28	29	30	31	32
Y	Y	N	N	N	N	N	N

ESC Y/N ENT PG UP/DN ↑↓ DONE:DOWN

PROGRAM FILE DOWNLOAD

This allows transfer of all of individual files to All, individual, or groups of terminals. Following is the file selections available for download

DOWNLOADING PROGRAM FILE SELECTION L1		DOWNLOADING PROGRAM FILE SELECTION L1	
1. REGISTER :	ALL REGISTERS		
2. PROGRAM FILE SELECTION		TRAINING MODE OPTION	N
DATE & TIME	N	LEVEL/MODIFIER OPTION	N
PLU	N	TRACKING FILE OPTION	N
PLU STATUS GROUP	N	KITCHEN PRINTING/VIDEO OPTION	N
GROUP	N	VALIDATION/SUBTOTAL PRINT OPTION	N
FUNCTION KEY	N	GENERAL PRINTING OPTION	N
MACRO	N	REPORT PRINTING OPTION	N
TARE WEIGHT	N	REPORT OPTION	N
GENERAL FUNCTION OPTION	N	TIME KEEPING OPTION	N
TAX OPTION	N	E.J. & DETAIL PRINTING OPTION	N
CASH DRAWER OPTION	N	TAX	N
		LOGO MESSAGE	N
▼ ESC Y/N ENT PG UP/DN ↑↓ DONE:DOWN		▲ ESC Y/N ENT PG UP/DN ↑↓ DONE:DOWN	

DOWNLOADING PROGRAM FILE SELECTION L1		DOWNLOADING PROGRAM FILE SELECTION L1	
ERROR MESSAGE	N	AUTHORITY LEVEL	N
SYSTEM DESCRIPTOR	N	SYSTEM PRINTER CONFIGURATION	N
FINANCIAL REPORT DESCRIPTOR	N	KITCHEN VIDEO ROUTING	N
EMPLOYEE REPORT DESCRIPTOR	N	KITCHEN PRINTER ROUTING	N
CHEQUE ENDORSEMENT MESSAGE	N	RECEIPT PRINTER ROUTING	N
GUEST CHECK LOGO MESSAGE	N	DETAIL PRINTER ROUTING	N
VALIDATION MESSAGE	N	INGREDIENT	N
WINDOW LOOK UP (WLU)	N	RECIPE TABLE	N
TIME PERIOD	N	TIME ACTIVATED KEYBOARD LEVEL	N
EMPLOYEE	N	TIME ACTIVATED PRICE LEVEL	N
JOB CODE	N	TIME ACTIVATED MACRO	N
PAYRATE	N	TIME ACTIVATED STRING REPORT	N
▲ ESC Y/N ENT PG UP/DN ↑↓ DONE:DOWN		▲ ESC Y/N ENT PG UP/DN ↑↓ DONE:DOWN	

DOWNLOADING PROGRAM FILE SELECTION L1		DOWNLOADING PROGRAM FILE SELECTION L1	
SHIFT TIME	N	PRINTER DRIVER	N
KP TIME PERIOD	N	BIT MAP IMAGE	N
PRODUCT MIX ITEMS	N	GROUPS BY EMPLOYEE	N
PRODUCT MIX GROUP TIME PERIOD	N	MIX & MATCH TABLE	N
CUSTOM REPORT	N		
EDIT FINANCIAL REPORT	N		
EDIT EMPLOYEE REPORT	N		
STRING REPORT	N		
PLU MINIMUM STOCK	N		
NON-PLU CODE	N		
KEYBOARD KEY RELOCATION	N		
S-MODE SYSTEM OPTION	N		
▲ ESC Y/N ENT PG UP/DN ↑↓ DONE:DOWN		▲ ESC Y/N ENT PG UP/DN ↑↓ DONE:DOWN	

P-MODE PROGRAM SCANS

This function allows you to print copies of the register's P-Mode programming.

P-MODE PROGRAMMING MENU	L1
13. INGREDIENT INVENTORY	
14. TIME ACTIVATED FUNCTIONS	
15. PRODUCT MIX GROUPS	
16. MIX & MATCH TABLE	
17. CUSTOM REPORT	
18. STRING REPORT	
19. PLU STOCK	
20. PLU MINIMUM STOCK	
21. COPY PROGRAM	
22. PROGRAM FILE DOWNLOAD	
23. P-MODE PROGRAM SCAN PRINTING	
24. NON-PLU CODE	
◆	ENTER PAGE UP/DN ↑↓

P-MODE PROGRAM SCAN PRINTING	L1
1. PLU BY RANGE	
2. PLU BY PLU STATUS GROUP	
3. PLU BY SELECTED PRICE LEVEL	
4. PLU STATUS GROUP BY RANGE	
5. GROUP BY RANGE	
6. ALL FUNCTION KEYS	
7. SYSTEM OPTION	
8. TAXES	
9. MESSAGES	
10. WINDOW LOOK UP (WLU)	
11. TIME PERIOD	
12. EMPLOYEE BY RANGE	
▼	ESC ENTER PAGE UP/DN ↑↓

P-MODE PROGRAM SCAN PRINTING	L1
13. JOB CODE	
14. PAY RATE	
15. AUTHORITY LEVEL	
16. PRINTER TABLES & KV ROUTING	
17. INGREDIENT INVENTORY	
18. TIME ACTIVATED FUNCTIONS	
19. PRODUCT MIX GROUPS	
20. MIX & MATCH TABLE	
21. CUSTOM REPORT	
22. STRING REPORT	
23. PLU STOCK BY RANGE	
24. PLU MINIMUM STOCK BY RANGE	
◆	ESC ENTER PAGE UP/DN ↑↓

NON PLU CODE PROGRAM

The NON-PLU Code program must be set if you wish to scan UPCs (using the EAN 13 code) with embedded prices, weights or quantities.

Within the EAN 13 code, the first two digits (part a) are used as an identifier and the last digit (part c) is used as a check digit. The remaining 10 digits (part b) contain the product code and the price (or weight or quantity).

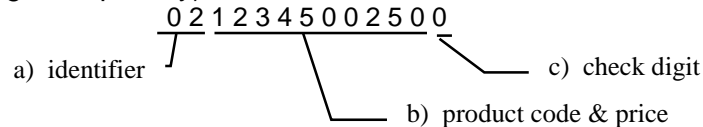

There are 11 identifier numbers available for non-PLU code programming: “02” and “20” through “29”. The purpose of this program is to define the format of the 10 digit part b for each possible identifier. For example:

- The structure of Non PLU identifier “02” can be defined to use 5 digits for the product code and 5 digits for the price.
- The structure of Non PLU identifier “20” can be defined to use 6 digits for the product code and 4 digits for the price.

P-MODE PROGRAMMING MENU L1

13. INGREDIENT INVENTORY

14. TIME ACTIVATED FUNCTIONS

15. PRODUCT MIX GROUPS

16. MIX & MATCH TABLE

17. CUSTOM REPORT

18. STRING REPORT

19. PLU STOCK

20. PLU MINIMUM STOCK

21. COPY PROGRAM

22. PROGRAM FILE DOWNLOAD

23. P-MODE PROGRAM SCAN PRINTING

24. NON-PLU CODE

⇅ ENTER PAGE UP/DN ↑↓

NON-PLU CODE PROGRAMMING L1

1. PLU#02~

2. PLU#20~

3. PLU#21~

4. PLU#22~

5. PLU#23~

6. PLU#24~

7. PLU#25~

8. PLU#26~

9. PLU#27~

10. PLU#28~

11. PLU#29~

ESC ENTER PAGE UP/DN ↑↓

NON-PLU# 1 (PLU#02~) PROGRAMMING L1

LENGTH OF FIELD 1 (=PLU CODE) **0**

LENGTH OF FIELD 2 0

CONTENT OF FIELD 2 PRICE

USE PRICE CHECK DIGIT? N

TAB OR DECIMAL POINT OF FIELD 2 0

ESC Y/N ENTER PAGE UP/DN ↑↓←→

NON PLU – DEFINITIONS

Non PLU program is used to define the format of price inclusive weight item barcodes.

PLU#02, PLU#20 ETC..

This is the format type of the barcode within this section the barcode layout is defined. The first two digits of the barcode define the barcode type

LENGTH OF FIELD 1 (= PLU CODE)

The digits immediately following the two digit barcode definition are the manufacturer s product code, this will be the PLU code for the item. This can change in length depending on the manufacturer. It is necessary to define how many digits are to be used for this format type

LENGTH OF FIELD 2

This is usually the price field although there are alternatives. The length of this field can vary for different barcode types. The length is defined in this field

CONTENT OF FIELD 2

This defines the content of field two the norm is the price although there are variations

USE PRICE CHECK DIGIT

Some barcode formats use a check digit to ensure the price of the product has been included within the barcode correctly. It must be determined which method is used and programmed in this field

TAB OR DECIMAL POINT OF FIELD 2

This is used to determine the number of decimal places for the price of the product

PLU & WLU KEY RELOCATION

PLU KEYS

This allocates PLU product numbers to keys, which have been defined as PLU keys within the function key program. This will provide one touch button product selling. Each of the five levels can have either the same product information or completely different product codes, or even a mix of each.

WLU KEYS (WINDOW LOOK UPS)

This allocates Window Look Up numbers to keys which have been defined as WLU keys within the function key program. This will provide one touch button menu selection. These menu windows can contain, products, function key lists, or condiment instructions or a combination of any of those. Each of the five levels can have either the same product information or completely different product codes, or even a mix of each.

P-MODE PROGRAMMING MENU	L1
16. MIX & MATCH TABLE 17. CUSTOM REPORT 18. STRING REPORT 19. PLU STOCK 20. PLU MINIMUM STOCK 21. COPY PROGRAM 22. PROGRAM FILE DOWNLOAD 23. P-MODE PROGRAM SCAN PRINTING 24. NON-PLU CODE 25. PLU & WLU KEY RELOCATION 26. BITMAP FILE DOWNLOAD 27. GROUPS BY EMPLOYEE	
▲	ENTER PAGE UP/DN ↑↓

PLU & WLU KEY RELOCATION	L1
<div style="border: 1px solid black; padding: 5px; margin-bottom: 10px;"> 1. PLU KEYS 2. WLU KEYS </div> <div style="border: 1px solid black; padding: 5px;"> 1. KEYBOARD LEVEL 1 2. KEYBOARD LEVEL 2 3. KEYBOARD LEVEL 3 4. KEYBOARD LEVEL 4 5. KEYBOARD LEVEL 5 </div>	
ESC ENTER PAGE UP/DN ↑↓	

PLU KEY RELOCATION PROGRAMMING	L1
KEYBOARD LEVEL 1	
<ul style="list-style-type: none"> •PRESS ANY KEY TO READ AND/OR CHANGE CURRENT ASSIGNMENT <p style="text-align: center;">OR</p> <ul style="list-style-type: none"> •PRESS ESC TO EXIT 	

PLU KEY RELOCATION PROGRAMMING	L1
KEYBOARD LEVEL : 1 KEY POSITION : 1 CURRENT PLU# 0000000000000001 SOUP & ROLL	
ESC ENTERED	

BITMAP FILE DOWNLOAD

The bitmap is designed on the PC and transmitted to the terminal using the required polling utility it can then be transmitted using program send to other terminals This procedure is used to transmit the bitmap image for the printer.

The same menu option can be accessed for the P-MODE menu.

Note: Ensure the printer is physically connected the terminal and in a ready state.

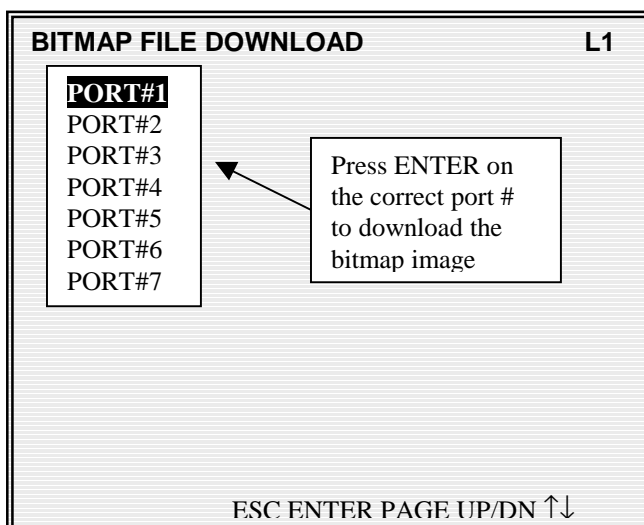
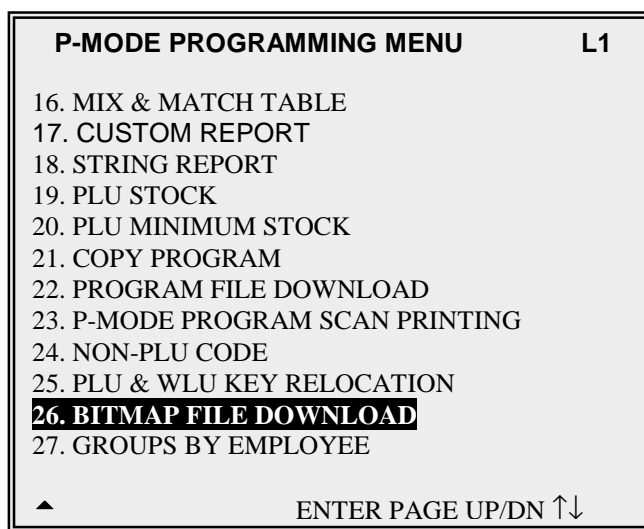



X-MODE

X-MODE MANAGER MENU

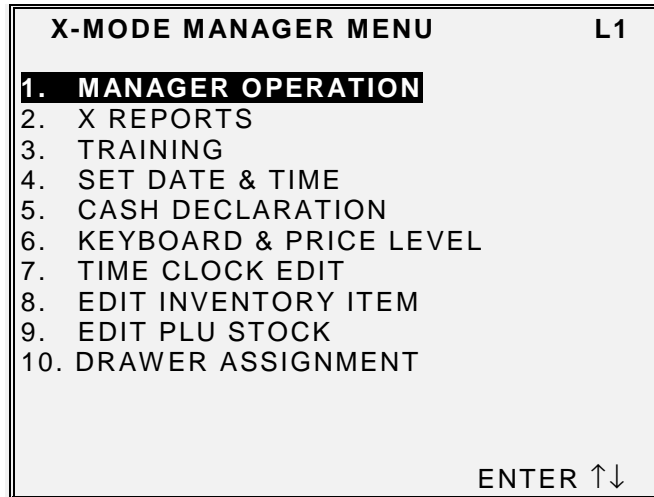

MANAGER OPERATION

Some functions are programmable to only operate when the register is in Manager Operation mode.

MANAGER CONTROL OF FUNCTIONS INSIDE OF A SALES TRANSACTIONS

If manager control is required to access a function inside of a sale, the message "MANAGER REQUIRED" will display when the function is attempted. Turn the key to the X position to perform the restricted function, then return the key to the register key position. The indicator MGR will display in the lower left portion of the display when the register is in manager operation mode.

MANAGER CONTROL OF FUNCTIONS OUTSIDE OF A SALES TRANSACTION

If manager control is required to access a function inside of a sale, the message "MANAGER REQUIRED" will display when the function is attempted. Turn the key to the X position, select "1 MANAGER OPERATION" to perform the restricted function, then return the key to the register key position. The indicator MGR will display in the lower left portion of the display when the register is in manager operation

X-MODE REPORTS MENU

Using the reporting screen, reports can be displayed to the screen or printed out

X-REPORTS	L1
REPORT#: 00	
• ENTER REPORT NUMBER AND PRESS ENTER	
• PRESS ENTER TO VIEW THE REPORT LIST	
• PRESS ESC TO RETURN TO THE X-MODE MANAGER MENU	
	ESC ENTER

X-REPORT LIST	L1
1. FINANCIAL	
2. SALES BY TIME PERIODS	
3. ALL PLUS	
4. FROM/TO PLUS	
5. PLUS BY GROUP	
6. PLUS BY GROUP FOR SELECTED GROUP	
7. TOP 20 PLUS	
8. PLU ZERO SALES	
9. PLU ZERO SALES BY GROUP	
10. PLU SALES BY PRICE LEVEL	
11. MIX AND MATCH	
12. NOT FOUND PLU	
▼	ESC ENTER PAGE UP/DN ↑↓

TRAINING

The register has various programmable training mode options these included; the ability to activate training mode by programming a selected training employee which can operate alongside normal registrations opening checks etc.. The checks opened by a training employee will be printed on the open check report indicated by [T]. There is also the programmable option of a training mode financial report. The following option activates training mode for the whole of the terminal

TRAINING	
• TRAINING MODE :	<input type="checkbox"/> OFF <input type="checkbox"/> ON
L1	ESC ENTER ↑↓

SET DATE & TIME

The current Date and Time is programmed in this section

SET DATE & TIME		L1
1. TIME : (00:00-23:59)		13:25
2. DATE :	MON 07-12-1999	
3. DATE PRINT :	MMDDYY•	
		ESC ENTER ↑↓

CASH DECLARATION

When compulsory declaration is set in the program options, the count of monies in drawer must be entered here before reports can be taken

CASH DECLARATION		L1
CASH	0.00	
CHEQUE	0.00	
MISC TEND#	0.00	
TOTAL	0.00	
CASH CHQ MISC DONE ESC		0.00

KEYBOARD & PRICE LEVEL

The terminal can be set to operate as default on any one of five keyboard levels and twenty price bands. The terminal will automatically, use this level and return to this level after any other levels have been selected and been completed

KEYBOARD & PRICE LEVEL	
KEYBOARD LEVEL (1-5) :	1
PRICE LEVEL (1-20) :	01
L1	ESC DONE ENTER ↑↓

TIME CLOCK EDIT

X/Z1(Daily), X/Z2, X/Z3, X/Z4 or X/Z5 time clock errors can be corrected with this function.

X/Z1 (DAILY) TIME CLOCK EDIT

X/Z1 (Daily) time entries can be amended for each operator

TIME CLOCK EDIT X/Z1(DAILY)					L1
#1 ANNIE W					
DATE : MON 07/12/1999					
IN	OUT	BRK	JOB#	JOB NAME	
12:12	- 12:20	1	01	MANAGER	
12:25	- 12:30	0	01	MANAGER	
00:00	- 00:00	0	00		
00:00	- 00:00	0	00		
00:00	- 00:00	0	00		
TIPS : 00000011.25					
▼ ESC DONE ENTER PAGE UP/DN ↑↓←→					

X/Z2 - X/Z5 TIME CLOCK EDIT

The hours work for the each can be amended for each employee

TIME CLOCK EDIT X/Z2				L1
#1 ANNIE W				
MANAGER	0000:13	REG	0000.00 OT	
SERVER	0000:00	REG	0000.00 OT	
HEAD SERVER	0000:00	REG	0000.00 OT	
CASHIER	0000:00	REG	0000.00 OT	
	0000:00	REG	0000.00 OT	
	0000:00	REG	0000.00 OT	
TIPS : 00000011.25				
ESC DONE ENTER PAGE UP/DN ↑↓←→				

EDIT INVENTORY ITEM

A *menu-explosion type inventory system* is set up when PLUs are linked to a recipe#) The X-MODE MANAGER MENU to receive, transfer in/out, or enter raw waste for ingredients in this system.

EDIT INVENTORY ITEM# 1	L1
SOUP	0.500
ACTUAL INVENTORY	00000.000
RECEIPT	00000.000
TRANSFER IN	00000.000
TRANSFER OUT	00000.000
RAW WASTE	00000.000
ESC ENTER PAGE UP/DN ↑↓	

ACTUAL INVENTORY

This is the field for entering the current stock holding

RECEIPT

This is the field for entering the quantity delivered

TRANSFER IN

This is the field for entering the quantity of goods transferred in

TRANSFER OUT

This is the field for entering the quantity of goods transferred out

RAW WASTE

This is the field for entering wastage of items

EDIT PLU STOCK

PLU stock is a simple inventory system where each whole unit PLU activity subtracts a value of "1" from the stock counter. The quantity modifier and stock link PLU programming can be used to link together two products so stock is reduced from one item with decimal quantity reduction if required.

PLU stock applies only to PLUs that are assigned to a PLU status group with the Stock PLU? setting set to Y Select PLU STOCK to maintain stock levels on PLUs selected for stock unit inventory.

NOTE: Be careful not to confuse the separate and distinct inventory features

- Recipes and Ingredients – Stock control of components making up a saleable product
 - Product Mix Groups usage analysis of a group of saleable products
 - PLU Stock – Stock control of saleable products
-

PLU STOCK MENU	L1			
<table border="1"><tr><td>1. ADD</td></tr><tr><td>2. OVERRIDE</td></tr><tr><td>3. SUBTRACT</td></tr></table>	1. ADD	2. OVERRIDE	3. SUBTRACT	
1. ADD				
2. OVERRIDE				
3. SUBTRACT				
ESC ENTER PAGE UP/DN ↑↓				

PLU#	000000000000000001	STOCK(ADD)
DESCRIPTOR :	BOTTLE BECKS	
STOCK		0.00
PLU# ESC Y/N ENT PAGE UP/DN ↑↓←→		

ADD

This adds to the existing stock figures. Used for deliveries transfers in etc..

SUBTRACT

This subtracts from the existing stock figures, Used for Returns, transfers out etc.

OVERRIDE

This overwrites the existing stock figures. Used for beginning inventory etc..

DRAWER ASSIGNMENT PROGRAMMING

Each employee can be allocated one of three drawer, this allocation can be set using the X-MODE menu or when defining employee program. When no drawer is allocated an employee is unable to accept payment for a sale.

DRAWER ASSIGNMENT PROGRAMMING	L1
EMPLOYEE# 1	
CURRENT DRAWER ASSIGNMENT (0-3)	1
NOTE : IF ASSIGNMENT IS 0, THEN ONLY POSTING TO A TRACKING FILE IS ALLOWED. CHECKS PAID AND/OR CASH TRANSACTIONS ARE NOT ALLOWED.	
ESC Y/N ENTER PAGE UP/DN ↑↓←→	



Z-MODE

Z-MODE REPORTING

The Z mode is used for display/printing of reports, all information can be reset at this stage.

NOTE Any report which is displayed during Z-MODE reporting will also reset those figure which appear. It is also important to report that some feature reports such as FOOD COST have a direct relationship to other reports for example resetting the PLU sales will result in no usage information printed for products on the food cost summary.

Z-REPORTS

Z-REPORTS	L1
REPORT#: 00	
<ul style="list-style-type: none">• ENTER REPORT NUMBER AND PRESS ENTER• PRESS ENTER TO VIEW THE REPORT LIST	
	ENTER

Z-REPORT LIST	L1
1. FINANCIAL	
2. SALES BY TIME PERIODS	
3. ALL PLUS	
4. FROM/TO PLUS	
5. PLUS BY GROUP	
6. PLUS BY GROUP FOR SELECTED GROUP	
10. PLU SALES BY PRICE LEVEL	
11. MIX AND MATCH	
12. NOT FOUND PLU	
13. EMPLOYEES	
14. INDIVIDUAL EMPLOYEE	
15. EMPLOYEE CURRENTLY SIGNED ON	
▼	ESC ENTER PAGE UP/DN ↑↓

Note If system option "CONFIRM PRINTING BEFORE RESETTING TOTALS ON Z" is selected, the following message appears

Z REPORT COMPLETED SUCCESSFULLY. DO YOU WISH TO RESET TOTALS? PRESS DONE TO RESET AND END THIS REPORT PRESS ESC TO EXIT REPORT WITHOUT RESETTING TOTALS
--



SAMPLE REPORTS

REPORT LIST

NO.	REPORT NAME	MODE	INDIVIDUAL / IRC
1	Financial	X1 / Z1 - X5 / Z5	INDIVIDUAL & IRC
2	Sales by Time Periods	X1 / Z1 - X5 / Z5	INDIVIDUAL & IRC
3	All PLUs	X1 / Z1 - X5 / Z5	INDIVIDUAL & IRC
4	From / To PLUs	X1 / Z1 - X5 / Z5	INDIVIDUAL & IRC
5	PLUs by Group	X1 / Z1 - X5 / Z5	INDIVIDUAL & IRC
6	PLUs by Group for Selected Group	X1 / Z1 - X5 / Z5	INDIVIDUAL & IRC
7	Top 20 PLUs	X1 to X5 read only	INDIVIDUAL & IRC
8	PLU Zero Sales	X1 to X5 read only	INDIVIDUAL & IRC
9	PLU Zero Sales by Group	X1 to X5 read only	INDIVIDUAL & IRC
10	PLU Sales by Price Level	X1 / Z1 - X5 / Z5	INDIVIDUAL & IRC
11	Mix and Match	X1 / Z1 - X5 / Z5	INDIVIDUAL & IRC
12	Not Found PLU	X1 & Z1 only	INDIVIDUAL
13	Employees	X1 / Z1 - X5 / Z5	INDIVIDUAL & IRC
14	Individual Employee	X1 / Z1 - X5 / Z5	INDIVIDUAL & IRC
15	Employee Currently Signed on	X1 / Z1 - X5 / Z5	INDIVIDUAL
16	Groups By Employee	X1 / Z1 - X5 / Z5	INDIVIDUAL & IRC
17	Groups	X1 / Z1 - X5 / Z5	INDIVIDUAL & IRC
18	From/To Groups	X1 / Z1 - X5 / Z5	INDIVIDUAL & IRC
19	Selective Group	X1 / Z1 - X5 / Z5	INDIVIDUAL & IRC
20	Drawer Totals	X1 to X5 read only	INDIVIDUAL & IRC
21	Drawer 1/2/3	X1 to X5 read only	INDIVIDUAL & IRC
22	Labour Groups	X1 / Z1 - X5 / Z5	IRC from REG holding data
23	Sales & Labour %	X1 / Z1 - X5 / Z5	IRC from REG holding data
24	Daily Sales	X2 & Z2	INDIVIDUAL & IRC
25	Groups By Time Periods	X1 / Z1 - X5 / Z5	INDIVIDUAL & IRC
26	Analysis 1 By Time Periods	X1 / Z1 - X5 / Z5	INDIVIDUAL & IRC
27	Analysis 2 By Time Periods	X1 / Z1 - X5 / Z5	INDIVIDUAL & IRC
28	Analysis 3 By Time Periods	X1 / Z1 - X5 / Z5	INDIVIDUAL & IRC
29	Track 1 By Time Periods	X1 / Z1 - X5 / Z5	INDIVIDUAL & IRC
30	Track 2 By Time Periods	X1 / Z1 - X5 / Z5	INDIVIDUAL & IRC
31	Track 3 By Time Periods	X1 / Z1 - X5 / Z5	INDIVIDUAL & IRC
32	Track 4 By Time Periods	X1 / Z1 - X5 / Z5	INDIVIDUAL & IRC
33	Open Check for Track 1	X1 & Z1	at REG holding data
34	Open Check for Track 2	X1 & Z1	at REG holding data
35	Open Check for Track 3	X1 & Z1	at REG holding data
36	Open Check for Track 4	X1 & Z1	at REG holding data
37	Open Check for Selected Employee	X1 & Z1	
38	Open Check for Current Employee	X1 & Z1	
39	Open Check for Track 1,2,3,&4	X1 & Z1	
40	Product Mix	X1 / Z1 - X2 / Z2	INDIVIDUAL & IRC
41	Product Projections	X1 read only	INDIVIDUAL & IRC
42	Station Totals	X1 / Z1	IRC
43	Active Employees – time keeping	X1 read only	IRC
44	Time Keeping	X1 / Z1 - X5 / Z5	IRC
45	Day Shift	X1 & Z1	INDIVIDUAL & IRC
46	Inventory	X1 & Z1	IRC
47	PLU Stock	X1 & Z1	INDIVIDUAL & IRC
48	Stock by PLU Range	X1 & Z1	INDIVIDUAL & IRC
49	Stock by Group	X1 & Z1	INDIVIDUAL & IRC
50	Stock by Individual Group	X1 & Z1	INDIVIDUAL & IRC
51	Food Cost	X1 & Z1	IRC
52	PLU Minimum Stock	X1 & Z1	INDIVIDUAL & IRC
53	Electronic Journal	X1 & Z1	INDIVIDUAL
54	String Report 1 – as defined by program	X1 / Z1 - X5 / Z5	INDIVIDUAL & IRC
55	String Report 2 – as defined by program	X1 / Z1 - X5 / Z5	INDIVIDUAL & IRC
56	String Report 3 – as defined by program	X1 / Z1 - X5 / Z5	INDIVIDUAL & IRC
57	String Report 4 – as defined by program	X1 / Z1 - X5 / Z5	INDIVIDUAL & IRC
58	Custom	X1 & Z1	INDIVIDUAL

59	Pre-Poll – Hard Copy Print Out		
----	--------------------------------	--	--

FINANCIAL

FINANCIAL REPORT		
X1 REPORT		0003
DESCRIPTOR	COUNT	TOTAL

+PLU LVL1 TTL	0	0.00
-PLU LVL1 TTL	0	0.00
+PLU LVL2 TTL	0	0.00
-PLU LVL2 TTL	0	0.00
	:	
+PLU LVL20 TTL	0	0.00
-PLU LVL20 TTL	0	0.00
ADJST TTL	0	0.00

NON-TAX		0.00
TAX1 SALES		0.00
TAX2 SALES		0.00
TAX3 SALES		0.00
TAX4 SALES		0.00
TAX5 SALES		0.00
TAX6 SALES		0.00
TAX1		0.00
TAX2		0.00
TAX3		0.00
TAX4		0.00
TAX5		0.00
TAX6		0.00
XMPTAX1 SALES		0.00
XMPTAX2 SALES		0.00
XMPTAX3 SALES		0.00
XMPTAX4 SALES		0.00
XMPTAX5 SALES		0.00
XMPTAX6 SALES		0.00

ANALYSIS1 SALES	0	0.00
ANALYSIS2 SALES	0	0.00
ANALYSIS3 SALES	0	0.00

% 1	0	0.00
% 2	0	0.00
% 3	0	0.00
% 4	0	0.00
% 5	0	0.00
% 6	0	0.00
% 7	0	0.00
% 8	0	0.00
% 9	0	0.00
% 10	0	0.00
NET SALES	0	0.00

CREDIT TAX1	0	0.00
CREDIT TAX2	0	0.00
CREDIT TAX3	0	0.00

CREDIT TAX4	0	0.00
CREDIT TAX5	0	0.00
CREDIT TAX6	0	0.00
FOOD STMP CREDIT		0.00
MDSE RETURN	0	0.00
ERROR CORRECT	0	0.00
PREVIOUS VOID	0	0.00
TRANS VOID	0	0.00
CANCEL	0	0.00
GROSS SALES		0.00

CASH SALES	0	0.00
CHEQUE SALES	0	0.00
R/A 1	0	0.00
R/A 2	0	0.00
R/A 3	0	0.00
R/A 4	0	0.00
R/A 5	0	0.00
P/O 1	0	0.00
P/O 2	0	0.00
P/O 3	0	0.00
P/O 4	0	0.00
P/O 5	0	0.00
HASH TOTAL	0	0.00
AUDACTION	0	0.00
NO SALE/NON-ADD#	0	0

CASH-IN-DRAWER		0.00
CHEQUE-IN-DRAWER	0	0.00
F/S-IN-DRAWER	0	0.00
MISC1 TEND	0	0.00
MISC2 TEND	0	0.00
	:	
MISC16 TEND	0	0.00
CONV1 CASH		*0.00
CONV2 CASH		@0.00
CONV3 CASH		@0.00
CONV4 CASH		@0.00
CONV5 CASH		@0.00
CONV1 CHEQUE		*0.00
CONV2 CHEQUE		@0.00
CONV3 CHEQUE		@0.00
CONV4 CHEQUE		@0.00
CONV5 CHEQUE		@0.00
CONV1 CHARGE		*0.00
CONV2 CHARGE		@0.00
CONV3 CHARGE		@0.00
CONV4 CHARGE		@0.00
CONV5 CHARGE		@0.00
DRAWER1 TOTAL		0.00
DRAWER2 TOTAL		0.00
DRAWER3 TOTAL		0.00

PROMO	0	0.00
WASTE	0	0.00

TRAINING TOTAL	0	0.00
BAL FORWARD	0	0.00
GUESTS	0	
PREVIOUS BALANCE	0	0.00
CHECKS PAID	0	0.00
SERVICE	0	0.00
TIP TOTAL	0	0.00

CASH DEC AMT	0	0.00
CHEQUE DEC AMT	0	0.00
MISC1 DEC AMT	0	0.00
MISC2 DEC AMT	0	0.00
	:	
MISC15 DEC AMT	0	0.00
MISC16 DEC AMT	0	0.00
COUPON SALES	0	0.00
ROUND TTL	0	0.00
M&M TTL	0	0.00
AVG. SALES		0.00

GRAND TOTAL(NEG)		0.00
GRAND TOTAL(NET)		0.00
GRAND TOTAL(GROSS)		0.00
NO.000013 REG 01 ANNIE W		TIME 19:03

SALES BY TIME PERIODS

SALES BY TIME PERIOD REPORT		
X1 REPORT		0003
TIME PERIOD	#/CUSTOMERS	TOTAL

08:00 - 08:59	3	11.54
09:00 - 09:59	15	186.82
11:00 - 11:59	6	7.99
12:00 - 12:59	1	2.40
14:00 - 14:59	13	146.82
TOTAL	38	355.57
NO.000013 REG 01 ANNIE W		TIME 19:03

PLU

- All Plus
- From/To PLUs
- PLUs By Group
- PLUs By Group For Selected Group
- Top 20 PLUs

ALL PLUS REPORT	
-----------------	--

- Whole unit reporting if there is no decimal activity.

- Total/Counter capacity

X1 REPORT					0003
ITEM	PROMO GROUP#	WASTE COUNT	USAGE	PLU#/%	TOTAL

HAMBURGER			00000000000000000001		
	1	2	6	50.00%	
	01	3			3.00
CHEESE BURGER			00000000000000000002		
	1	4	8	50.00%	
	01	3			3.00
TOTAL					
	2	6	14		
		6			6.00
NO.000013 REG 01 ANNIE W					TIME 19:03

PLU ZERO SALES

PLU Zero Sales
PLU Zero Sales By Group

PLU ZERO SALES REPORT					
X1 REPORT					0003
ITEM					PLU#

PLU3			00000000000000000003		
PLU4			00000000000000000004		
		:			
NO.000013 REG 01 ANNIE W					TIME 19:03

PLU SALES BY PRICE LEVEL

PLU SALES BY PRICE LEVEL REPORT				
X1 REPORT				0003
ITEM	PROMO GROUP#	WASTE COUNT	USAGE	PLU#/% TOTAL
HAMBURGER			000000000000000001	
	1	2	6	50.00%
	01	3		3.00
PRICE LVL1		3		3.00
PRICE LVL2		0		0.00
PRICE LVL3		0		0.00
PRICE LVL4		0		0.00
PRICE LVL5		0		0.00
		:		
TOTAL			14	
	2	6		
		6		6.00
PRICE LVL1		6		6.00
PRICE LVL2		0		0.00
PRICE LVL3		0		0.00
PRICE LVL4		0		0.00
PRICE LVL5		0		0.00
PRICE LVL6		0		0.00
PRICE LVL7		0		0.00
PRICE LVL8		0		0.00
PRICE LVL9		0		0.00
PRICE LVL10		0		0.00
PRICE LVL11		0		0.00
PRICE LVL12		0		0.00
PRICE LVL13		0		0.00
PRICE LVL14		0		0.00
PRICE LVL15		0		0.00
PRICE LVL16		0		0.00
PRICE LVL17		0		0.00
PRICE LVL18		0		0.00
PRICE LVL19		0		0.00
PRICE LVL20		0		0.00
NO.000013 REG 01 ANNIE W			TIME	19:03

MIX AND MATCH

MIX AND MATCH REPORT			
X1 REPORT			0003
#/DESCRIPTION	COUNT	TOTAL	%
001 DISCOUNT#1	3	0.30	20.00
002 DISCOUNT#2	4	12.00	80.00
003 DISCOUNT#3	0	0.00	
004 DISCOUNT#4	0	0.00	
005 DISCOUNT#5	0	0.00	
TOTAL	7	12.30	
NO.000013 REG 01 ANNIE W			TIME 19:03

NOT FOUND PLU

NOT FOUND PLU REPORT	
X1 REPORT	
0003	
DESCRIPTOR	NOT FOUND PLU#
CHICKEN NUGGET	000000000000001000
FANTA	0000000000000010104
NO.000013 REG 01 ANNIE W	
TIME 19:03	

EMPLOYEES

Employees
 Individual Employee
 Employee Currently Signed On
 Active Employees

INDIVIDUAL EMPLOYEE REPORT		
X1 REPORT		0003
EMPLOYEE #1	ANNIE W	
DESCRIPTOR	COUNT	TOTAL

NET SALES	0	0.00
NON-TAX		0.00
TAX1 SALES		0.00
TAX2 SALES		0.00
TAX3 SALES		0.00
TAX4 SALES		0.00
TAX5 SALES		0.00
TAX6 SALES		0.00
TAX1		0.00
TAX2		0.00
TAX3		0.00
TAX4		0.00
TAX5		0.00
TAX6		0.00
XMPTAX1 SALES		0.00
XMPTAX2 SALES		0.00
XMPTAX3 SALES		0.00
XMPTAX4 SALES		0.00
XMPTAX5 SALES		0.00
XMPTAX6 SALES		0.00

ANALYSIS1 SALES	0	0.00
ANALYSIS2 SALES	0	0.00
ANALYSIS3 SALES	0	0.00

% 1	0	0.00
% 2	0	0.00
% 3	0	0.00
% 4	0	0.00
% 5	0	0.00
% 6	0	0.00
% 7	0	0.00
% 8	0	0.00
% 9	0	0.00
% 10	0	0.00

CREDIT TAX1	0	0.00
CREDIT TAX2	0	0.00
CREDIT TAX3	0	0.00
CREDIT TAX4	0	0.00
CREDIT TAX5	0	0.00

CREDIT TAX6	0	0.00
FOOD STMP CREDIT		0.00
MDSE RETURN	0	0.00
ERROR CORRECT	0	0.00
PREVIOUS VOID	0	0.00
TRANS VOID	0	0.00
CANCEL	0	0.00
GROSS SALES		0.00

CASH SALES	0	0.00
CHEQUE SALES	0	0.00
R/A 1	0	0.00
R/A 2	0	0.00
R/A 3	0	0.00
R/A 4	0	0.00
R/A 5	0	0.00
P/O 1	0	0.00
P/O 2	0	0.00
P/O 3	0	0.00
P/O 4	0	0.00
P/O 5	0	0.00
HASH TOTAL	0	0.00
AUDACTION	0	0.00
NO SALE/NON-ADD#	0	0

CASH-IN-DRAWER	0	0.00
CHEQUE-IN-DRAWER	0	0.00
F/S-IN-DRAWER	0	0.00
MISC1 TEND	0	0.00
MISC2 TEND	0	0.00
	:	
MISC16 TEND	0	0.00
CONV1 CASH		*0.00
CONV2 CASH		@0.00
CONV3 CASH		@0.00
CONV4 CASH		@0.00
CONV5 CASH		@0.00
CONV1 CHEQUE		*0.00
CONV2 CHEQUE		@0.00
CONV3 CHEQUE		@0.00
CONV4 CHEQUE		@0.00
CONV5 CHEQUE		@0.00
CONV1 CHARGE		*0.00
CONV2 CHARGE		@0.00
CONV3 CHARGE		@0.00
CONV4 CHARGE		@0.00
CONV5 CHARGE		@0.00
DRAWER1 TOTAL	0	0.00
DRAWER2 TOTAL	0	0.00
DRAWER3 TOTAL	0	0.00

PROMO	0	0.00
WASTE	0	0.00
TRAINING TOTAL	0	0.00

BAL FORWARD	0	0.00
GUESTS	0	
PREVIOUS BALANCE	0	0.00
CHECKS PAID	0	0.00
SERVICE	0	0.00
TIP TOTAL	0	0.00

ROUND TTL	0	0.00
M&M TTL	0	0.00
NO.000013 REG 01 ANNIE W		TIME 19:03

GROUPS BY EMPLOYEE

GROUPS BY EMPLOYEE REPORT		
X1 REPORT		0003
EMPLOYEE #1	ANNIE W	
DESCRIPTOR	COUNT	TOTAL

GROUP1	3	30.00
GROUP2	4	80.00
TOTAL	7	110.00
:		
NO.000013 REG 01 ANNIE W		TIME 19:03

GROUP

Groups
From/To Groups
Selective Group

GROUPS REPORT				
X1 REPORT				0003
#	DESCRIPTOR	COUNT	TOTAL	%
01	GROUP1	3	30.00	27.27
02	GROUP2	4	80.00	72.72
GROUP TOTAL		7	110.00	
NO.000013 REG 01 ANNIE W				TIME 19:03

DRAWER TOTALS

DRAWER TOTALS REPORT			
X1 REPORT			
DESCRIPTOR		COUNT	TOTAL
R/A 1		0	0.00
R/A 2		0	0.00
R/A 3		0	0.00
R/A 4		0	0.00
R/A 5		0	0.00
P/O 1		0	0.00
P/O 2		0	0.00
P/O 3		0	0.00
P/O 4		0	0.00
P/O 5		0	0.00
CASH-IN-DRAWER			0.00
CHEQUE-IN-DRAWER		0	0.00
F/S-IN-DRAWER		0	0.00
MISC1 TEND		0	0.00
MISC2 TEND		0	0.00
	:		
MISC16 TEND		0	0.00
CONV1 CASH			*0.00
CONV2 CASH			@0.00
CONV3 CASH			@0.00
CONV4 CASH			@0.00
CONV5 CASH			@0.00
CONV1 CHEQUE			*0.00
CONV2 CHEQUE			@0.00
CONV3 CHEQUE			@0.00
CONV4 CHEQUE			@0.00
CONV5 CHEQUE			@0.00

CONV1 CHARGE		*0.00
CONV2 CHARGE		@0.00
CONV3 CHARGE		@0.00
CONV4 CHARGE		@0.00
CONV5 CHARGE		@0.00
COUPON SALES	0	0.00
NO.000013 REG 01 ANNIE W		TIME 19:03

LABOUR GROUPS

LABOR GROUPS REPORT	
X1 REPORT	IRC REG#01 0003
DESCRIPTOR	HOURS/MINUTES

MANAGER	0.00
SERVER	0.00
HEAD SERVER	0.00
CASHIER	0.00
	:
JOB#20	0.00
TOTAL TIME WORKED	0.00
AVG. DAILY LABOR COST	0.00
NO.000013 REG 01 ANNIE W	TIME 19:03

SALES AND LABOUR %

SALES AND LABOR % REPORT	
X1 REPORT	IRC REG#01 0001
TIME PERIOD / ITEM	

00:00 - 00:59	
CUST: 0	NET SALES: 0.00
	AVG/CUST: 0.00
HRS LBR: 0.00	LABOR COST: 0.00
	%/NET SALES:
LABOR\$/CUST:	0.00
SALES/MANHOURL:	0.00
	:
23:00 - 23:59	
CUST: 0	NET SALES: 0.00
	AVG/CUST: 0.00
HRS LBR: 0.00	LABOR COST: 0.00
	%/NET SALES:
LABOR\$/CUST:	0.00
SALES/MANHOURL:	0.00
TOTAL	
CUST: 0	NET SALES: 0.00
	AVG/CUST: 0.00
HRS LBR: 0.00	LABOR COST: 0.00
	%/NET SALES: 100.00%
LABOR\$/CUST:	0.00
SALES/MANHOURL:	0.00
NO.000013 REG 01 ANNIE W	TIME 19:03

DAILY SALES

DAILY SALES REPORT		
X2 REPORT		0001
DAY	COUNT	TOTAL
-----	-----	-----
1	3	11.54
2	15	186.82
3	6	7.99
13	1	2.40
17	13	146.82
TOTAL	38	355.57
NO.000013 REG 01 ANNIE W		TIME 19:03

GROUPS BY TIME PERIOD

Reporting for each time period and each group. (Selected groups and periods shown here to provide format.)

GROUPS BY TIME PERIODS REPORT			
X1 REPORT			0001
TIME PERIOD	COUNT	TOTAL	AV/TRNS
-----	-----	-----	-----
00:00-00:59	0	0.00	
DESCRIPTOR	COUNT		TOTAL
GROUP1	0		0.00
GROUP2	0		0.00
	:		
GROUP99	0		0.00
-----	-----	-----	-----
	:		
-----	-----	-----	-----
12:00-12:59	7	110.00	15.71
DESCRIPTOR	COUNT		TOTAL
GROUP1	3		30.00
GROUP2	4		80.00
	:		
GROUP99	0		0.00
-----	-----	-----	-----
	:		
-----	-----	-----	-----
TOTAL	7	110.00	15.71
NO.000013 REG 01 ANNIE W		TIME 19:03	

ANALYSIS 1 BY TIME PERIODS

ANALYSIS1 BY TIME PERIODS REPORT			
X1 REPORT			0001
TIME PERIOD	#/CUSTOMERS		TOTAL

00:00 - 00:59	0		0.00
01:00 - 01:59	0		0.00
	:		
23:00 - 23:59	0		0.00
TOTAL	0		0.00
NO.000013 REG 01 ANNIE W			TIME 19:03

ANALYSIS 2 BY TIME PERIODS

ANALYSIS2 BY TIME PERIODS REPORT			
X1 REPORT			0001
TIME PERIOD	#/CUSTOMERS		TOTAL

00:00 - 00:59	0		0.00
01:00 - 01:59	0		0.00
	:		
23:00 - 23:59	0		0.00
TOTAL	0		0.00
NO.000013 REG 01 ANNIE W			TIME 19:03

ANALYSIS 3 BY TIME PERIODS

ANALYSIS3 BY TIME PERIODS REPORT			
X1 REPORT			0001
TIME PERIOD	#/CUSTOMERS		TOTAL

00:00 - 00:59	0		0.00
01:00 - 01:59	0		0.00
	:		
23:00 - 23:59	0		0.00
TOTAL	0		0.00
NO.000013 REG 01 ANNIE W			TIME 19:03

TRACK BY TIME PERIODS

- Track 1 By Time Periods
- Track 2 By Time Periods
- Track 3 By Time Periods
- Track 4 By Time Periods

TRACK 1 BY TIME PERIODS REPORT			
X1 REPORT			0001
TIME PERIOD	#/CUSTOMERS		TOTAL

00:00 - 00:59	0		0.00
01:00 - 01:59	0		0.00
	:		
23:00 - 23:59	0		0.00
TOTAL	0		0.00
NO.000013 REG 01 ANNIE W			TIME 19:03

OPEN CHECK

- Open Check For Track 1
- Open Check For Track 2
- Open Check For Track 3
- Open Check For Track 4
- Open Check For Selected Employee
- Open Check For Current Employee
- Open Check For Track 1,2,3,&4

OPEN CHECK FOR TRACK 1 REPORT					
X1 REPORT					0003
TBL#	CHECK#	G#	EMPLOYEE	TIME	TOTAL

				IRC REG#01	
0001		2		11:11	
	0000000100		ANNIE W		100.00
TRACK#1 TOTAL					100.00
NO.000013 REG 01 ANNIE W					TIME 19:03

PRODUCT MIX

PRODUCT MIX REPORT			
X1 REPORT			0003
PRODUCT/TIME	UNIT#PC	COUNT	TOTAL

BOTTLE BECKS (CASE)			

09:00-09:59	0001#084	204	222.36
10:00-10:59	0001#033	153	166.77
13:00-13:59	0002#004	244	265.96
TOTAL	0005#001	601	655.09
NO.000013 REG 01 ANNIE W TIME 19:03			

PRODUCT PROJECTIONS

PRODUCT PROJECTIONS REPORT					
X1 REPORT					0003
BOTTLE BECKS (CASE)					MON

TIME	WEEK1	WEEK2	WEEK3	WEEK4	AVG
06:00-06:29	5	5	5	5	5.0
08:00-08:29	10	20	30	40	25.0
08:30-08:59	0	0	0	700	175
09:30-09:59	0	0	68	1	17.2
TOTAL	15	25	103	746	222.2
NO.000013 REG 01 ANNIE W TIME 19:03					

STATION TOTALS

Prints for each register in an IRC configuration.

STATION TOTALS REPORT		
X1 REPORT		0003
DESCRIPTOR	COUNT	TOTAL

		IRC REG#01
NET SALES	14	1942.68
GROSS SALES		1942.68
DRAWER1 TOTAL		1894.00
DRAWER2 TOTAL		38.68
DRAWER3 TOTAL		10.00
DRAWER123 TOTAL		1942.68

TIME KEEPING

Time Keeping X/Z1

TIME KEEPING REPORT			
X1 REPORT			IRC REG#01 0003
EMP#	SSN	NAME	TIPS
001	NG 5861 34A	ANNIE W	5.00
	08:30 - 12:30	MANAGER	
	13:30 - 17:30	MANAGER	
	18:00 - 20:15	HEAD SERVER	
MANAGER	8.00	REG	0.00 OT
HEAD SERVER	2.15	REG	0.00 OT
TOTAL REG	10.15	HR	56.92 CST
TOTAL OT	0.00	HR	0.00 CST
TOTAL LBR	10.15	HR	56.92 CST

MANAGER			
REG	8.00	HR	47.92 CST
OT	0.00	HR	0.00 CST
TOTAL LBR	8.00	HR	47.92 CST
HEAD SERVER			
REG	2.15	HR	9.00 CST
OT	0.00	HR	0.00 CST
TOTAL LBR	2.15	HR	9.00 CST
TOTAL			
REG	10.15	HR	56.92 CST
OT	0.00	HR	0.00 CST
TOTAL LABOR	10.15	HR	56.92 CST
TOTAL TIPS	5.00	TIP%	0.00
NO.000013 REG 01 ANNIE W			TIME 19:03

Time Keeping X/Z2-5

TIME KEEPING REPORT			
X2 REPORT			IRC REG#01 0003

EMP#	SSN	NAME	TIPS
001	NG 5861 34A	ANNIE W	5.00
MANAGER	8.00	REG	0.00 OT
HEAD SERVER	2.15	REG	0.00 OT
TOTAL REG	10.15	HR	56.92 CST
TOTAL OT	0.00	HR	0.00 CST
TOTAL LBR	10.15	HR	56.92 CST

MANAGER			
REG	8.00	HR	47.92 CST
OT	0.00	HR	0.00 CST
TOTAL LBR	8.00	HR	47.92 CST
HEAD SERVER			
REG	2.15	HR	9.00 CST
OT	0.00	HR	0.00 CST
TOTAL LBR	2.15	HR	9.00 CST
TOTAL			
REG	10.15	HR	56.92 CST
OT	0.00	HR	0.00 CST
TOTAL LABOR	10.15	HR	56.92 CST
TOTAL TIPS	5.00	TIP%	0.00
NO.000013 REG 01 ANNIE W TIME 19:03			

DAY SHIFT

Complete Financial Reporting is available for each of 4 possible shifts. Shifts can be changed automatically at a set time or manually.

DAY SHIFT#1 REPORT			
X1 REPORT			0003
			00:00-11:59
DESCRIPTOR		COUNT	TOTAL

+PLU LVL1 TTL		0	0.00
-PLU LVL1 TTL		0	0.00
+PLU LVL2 TTL		0	0.00
-PLU LVL2 TTL		0	0.00
	:		
+PLU LVL20 TTL		0	0.00
-PLU LVL20 TTL		0	0.00
ADJST TTL		0	0.00

NON-TAX			0.00
TAX1 SALES			0.00
TAX2 SALES			0.00
TAX3 SALES			0.00
TAX4 SALES			0.00
TAX5 SALES			0.00
TAX6 SALES			0.00
TAX1			0.00
TAX2			0.00
TAX3			0.00
TAX4			0.00
TAX5			0.00
TAX6			0.00
XMPTAX1 SALES			0.00
XMPTAX2 SALES			0.00
XMPTAX3 SALES			0.00
XMPTAX4 SALES			0.00
XMPTAX5 SALES			0.00
XMPTAX6 SALES			0.00

ANALYSIS1 SALES		0	0.00
ANALYSIS2 SALES		0	0.00
ANALYSIS3 SALES		0	0.00

% 1		0	0.00
% 2		0	0.00
% 3		0	0.00
% 4		0	0.00
% 5		0	0.00
% 6		0	0.00
% 7		0	0.00
% 8		0	0.00
% 9		0	0.00
% 10		0	0.00
NET SALES		0	0.00

CREDIT TAX1		0	0.00

CREDIT TAX2	0	0.00
CREDIT TAX3	0	0.00
CREDIT TAX4	0	0.00
CREDIT TAX5	0	0.00
CREDIT TAX6	0	0.00
FOOD STMP CREDIT		0.00
MDSE RETURN	0	0.00
ERROR CORRECT	0	0.00
PREVIOUS VOID	0	0.00
TRANS VOID	0	0.00
CANCEL	0	0.00
GROSS SALES		0.00

CASH SALES	0	0.00
CHEQUE SALES	0	0.00
R/A 1	0	0.00
R/A 2	0	0.00
R/A 3	0	0.00
R/A 4	0	0.00
R/A 5	0	0.00
P/O 1	0	0.00
P/O 2	0	0.00
P/O 3	0	0.00
P/O 4	0	0.00
P/O 5	0	0.00
HASH TOTAL	0	0.00
AUDACTION	0	0.00
NO SALE/NON-ADD#	0	0

CASH-IN-DRAWER		0.00
CHEQUE-IN-DRAWER	0	0.00
FD/S-IN-DRAWER	0	0.00
MISC1 TEND	0	0.00
MISC2 TEND	0	0.00
MISC16 TEND	0	0.00
CONV1 CASH		*0.00
CONV2 CASH		@0.00
CONV3 CASH		@0.00
CONV4 CASH		@0.00
CONV5 CASH		@0.00
CONV1 CHEQUE		*0.00
CONV2 CHEQUE		@0.00
CONV3 CHEQUE		@0.00
CONV4 CHEQUE		@0.00
CONV5 CHEQUE		@0.00
CONV1 CHARGE		*0.00
CONV2 CHARGE		@0.00
CONV3 CHARGE		@0.00
CONV4 CHARGE		@0.00
CONV5 CHARGE		@0.00
DRAWER1 TOTAL		0.00
DRAWER2 TOTAL		0.00
DRAWER3 TOTAL		0.00

PROMO	0	0.00
WASTE	0	0.00
TRAINING TOTAL	0	0.00
BAL FORWARD	0	0.00
GUESTS	0	
PREVIOUS BALANCE	0	0.00
CHECKS PAID	0	0.00
SERVICE	0	0.00
TIP TOTAL	0	0.00

CASH DEC AMT	0	0.00
CHEQUE DEC AMT	0	0.00
MISC1 DEC AMT	0	0.00
MISC2 DEC AMT	0	0.00
	:	
MISC15 DEC AMT	0	0.00
MISC16 DEC AMT	0	0.00
COUPON SALES	0	0.00
ROUND TTL	0	0.00
NO.000013 REG 01 ANNIE W		TIME 19:03

INVENTORY

INVENTORY REPORT	
CONSOLIDATED	(01)
X1 REPORT	0003
INV #001	PATTY

BEGINING INVENTORY	00.000
RECEIPTS	00.000
TRANSFER INS	00.000
TRANSFER OUTS	00.000
RAW WASTE	00.000
THEORETICAL USAGE	00.000
ACTUAL INVENTORY	00.000
ACTUAL USAGE	00.000

VALUE OF INVENTORY	00.000
VARIANCE +/-	00.000
VARIANCE COST	00.000
FOOD COST	00.000
:	
INVENTORY TOTAL	

PLU RECIPE SALES	00.000
FOOD COST	00.000
VALUE OF INVENTORY	00.000
VARIANCE COST	00.000
NO.000013	REG 01 ANNIE W
	TIME 19:03

INVENTORY DEFINITIONS

BEGINNING INVENTORY

The Beginning Quantity as Receipt Quantity entered in X-mode (EDIT INVENTORY ITEM), for the first report. Additional reports will get the begin quantity from the END value from the last “Z” reset report.

RECEIPTS

The Receipt Quantity as entered in X-mode (EDIT INVENTORY ITEM).

TRANSFER IN

The Transfer In Quantity as entered in X-mode (EDIT INVENTORY ITEM)

TRANSFER OUT

The Transfer Out Quantity as entered in X-mode (inventory - edit inventory item -daily edit/period)

RAW WASTE

The Raw Waste Quantity as entered in X-mode (EDIT INVENTORY ITEM).

THEORETICAL USAGE

The Theoretical Use Quantity.

T.USAGE = [(PROMO + WASTE + SOLD (PLU Report)) * [QTY (RECIPE TABLE)]

ACTUAL INVENTORY

The Actual Inventory as entered in X-mode (EDIT INVENTORY ITEM).

ACTUAL USAGE

The Actual Use Quantity.

At the first report,

A.USAGE = [(RECEIPTS) + (TR/IN) - (TR/OUT) - (RAW WASTE) - (ACTUAL INV.)]

At the additional reports,

A.USAGE = [(BEGINNING INV.) + (RECEIPTS) + (TR/IN) - (TR/OUT)
- (RAW WASTE) - (ACTUAL INV)]

VALUE OF INVENTORY

The Value of inventory items on hand. VALUE = [(END) * (COST)]

VARIANCE +/-

The Variance +/-. VR+/- = [(T.USAGE) - (A.USAGE)]

VARIANCE COST

The Variance Cost. V.CST = [(VR+/-) * (COST)]

FOOD COST

The Food Cost. FDCST = [(A.USAGE) * (COST)]

PLU STOCK

PLUs designated as stock PLUs (see PLU Status Group Programming) will appear on this report.

PLU Stock
Stock By PLU Range

PLU STOCK REPORT		
X1 REPORT		0003
PLU#	DESCRIPTOR	COUNT

00000000000000000001	HAMBURGER	50
00000000000000000002	CHEESE BURGER	24
NO.000013 REG 01 ANNIE W		TIME 19:03

PLU STOCK BY GROUP

Further stock reporting formats are available

Stock By Group
Stock By Individual Group

STOCK BY GROUP REPORT		
X1 REPORT		0003
GROUP/PLU#	DESCRIPTOR	COUNT

01 GROUP1		
00000000000000000001	HAMBURGER	50
00000000000000000002	CHEESE BURGER	24
GROUP1 TOTAL		74
02 GROUP2		
00000000000000000011	COKE	100
00000000000000000012	FANTA	67
GROUP2 TOTAL		167

TOTAL		241
NO.000013 REG 01 ANNIE W		TIME 19:03

FOOD COST

FOOD COST REPORT		
CONSOLIDATED	(01)	
X1 REPORT		0003
HAMBURGER	PRICE	1.95

PLU#00000000000000000001		
USAGE COUNT		28
ITEM COST		1.200
USAGE COST		33.600
SALES COUNT		28
NET SALES		54.60
:		
PLU COST TOTAL		

TOTAL FOOD COST		269.850
TOTAL SALES COUNT		133
NET SALES TOTAL		1309.35
NO.000013	REG 01 ANNIE W	TIME 19:03

DEFINITIONS

USAGE COUNT

(SALES COUNT + PROMO COUNT + WASTE COUNT)

ITEM COST

COMBINED COST OF ALL INGREDIENTS\RECIPIES ASSOCIATED WITH THE ITEM.

USAGE COST

(USAGE * ITEM COST)

SALES COUNT

(SALES COUNT)

NET SALES

(SALES COUNT * PRICE)

PLU MINIMUM STOCK

This report shows PLUs their stock counter are less than or equal to minimum stock counter

PLU MINIMUM STOCK REPORT		
X1 REPORT		0003
DESCRIPTOR/PLU#	MIN.STK	STK

HAMBURGER		
000000000000000001	100	50
COKE		
000000000000000011	120	100
NO.000013 REG 01 ANNIE W		TIME 19:03

ELECTRONIC JOURNAL

This terminal has a very sophisticated analysis on journal reporting. All information can be selected by individual transaction type to be stored and reported extracted as required i.e. all Cash Transactions, VOIDS etc

- CASH TRANSACTIONS** - All cash sales made during normal operation
- CHEQUE TRANSACTIONS** - All check sales made during normal operation
- MISC TENDER TRANSACTIONS** - All Miscellaneous tender operations made during normal operation
 - All sales containing a discount or premium operation
 - All received on account or Paid out sales transactions
- TRANSACTIONS WITH %**
- RECD ACCT & PAID OUT**
- RETURN TRANSACTIONS** - All Merchandise Return sales transactions
- WITH ERROR CORRECTS & VOIDS** - All Transactions containing an error correct or voids.
- NO SALES** - All Transactions containing no sale operations.
- CANCEL TRANSACTIONS** - All Register Mode cancelled transactions
- TRANSACTIONS WITH NEGATIVE** - All Transactions with negative product sales.
- REPORTS** - All Read & Reset reports which are printed
- PROGRAM SCANS** - All Program scans which are printed.
- CHECK TRACKING** - All sales registered for open checks.



APPENDIX - TECHNICAL

BITMAP FILE DOWNLOAD

This provides a method of printing a graphics logo on the printer, please ensure the necessary memory allocation are set at the initial stages as these cannot be re-selected once programming of the terminal has commenced.

PREPARE THE SPS1000 BITMAP DOWNLOAD

- In the S-Mode MEMORY ALLOCATION, set to Y the STORE BITMAP item..

This setting must be carried during the initial program reset procedure.

- In the S-Mode SERIAL PORT DEVICE SELECTIONS, set the port where PC is connected to POLLING.

BIT MAP FILE SPECIFICATION

- This procedure states how to save bit map files made using the Microsoft Paint software, and then how to down load them to the SPS-1000
- The Maximum file size which can be downloaded to the SPS-1000 is 12288 bytes.
- The Image dimensional definition is as follows

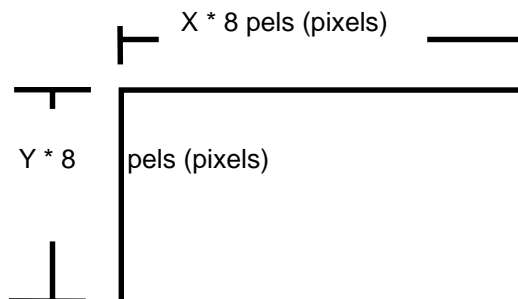

The possible values of X and Y and the product of X and Y are:

$$1 \leq X \leq 255$$

$$1 \leq Y \leq 48$$

- **HOWEVER**, the product of X and Y must be

$$1 \leq X*Y \leq 1536$$

- A good size to use is 432 pixels wide by 144 pixels high.

BITMAP FILE DOWNLOAD

DESIGN & SAVE A LOGO USING MICROSOFT PAINT

Set the Bit Map size as required (A good size to use is 432 pixels wide by 144 pixels high.)



- Select IMAGE
- Select ATTRIBUTES
- Set Units = PELS
- Set Colors = Black and White
- Enter the width and height of the bit map. Values must be in multiples of 8
- (or above for Bit Map file specifications).

Design the Bit Map Image. Then prior to saving the Bit Map Image

- Select IMAGE
- Select INVERT COLORS
- Select IMAGE again
- Select FLIP/ROTATE
- Select ROTATE BY ANGLE
- Select 90 DEGREES repeat 2 more times to obtain a rotation of 270 degrees in total.

Save the Bit Map Image.

Example:

Image to Print, (created in Paint Brush)	Image should be saved as
	

PC- SETUP OF A BITMAP

CONVERTING THE BITMAP FOR THE SPS1000

- Run the **CONV_BMP.EXE** program
- Enter the filename without the extension (.bmp).
- Output filename is the same and the extension becomes **DAT**.

DOWNLOADING THE BITMAP TO THE SPS1000

- Place the file in the appropriate directory. E.g. C:\SPS1000_ _ 000000
- Rename the file with the extension .dat to **BIT_MAP.PGM**.
- Run PC utility program by loading the SYSTEM file
- Select the store number this is usually 0000
- Set the environment (i.e. the number of registers etc.)
- Select this option from the TOOL menu option.
- Select FILE UP from the UP menu option
- Enter the File Number 250 to be uploaded then press ENTER key.
- Select FILE DOWN from the DOWN menu option
- Enter the File Number 83 and then press ENTER key.

DOWNLOADING THE BITMAP FILE TO THE PRINTER

- In the S-Mode SERIAL PORT DEVICE SELECTION, setup the printer as normal.
- Select BITMAP FILE DOWNLOAD in P-MODE.
- Select the port number which the printer is connected and press ENTER

PRINTING THE BITMAP IMAGE

The following programming procedures can be found in detail within the programming manual

- In the PRINTER DRIVER SELECTIONS screen in S-mode, select the printer model
- Then delete the INITIALIZE command code.
- In the DEFINE SERIAL PORT PARAMETERS ,set the port for the printer Then set PRINT BITMAP to Y.
- Select the LOGO SIZE to be printed.
- It is then required you program a printer to the system using the S-MODE
- To test the printing, make a transaction and then press the RECEIPT ISSUE key.

PC- FLASH ROM DOWNLOAD

This is used to transmit a ROM from the PC to one terminal, the s-mode flash ROM download will transmit from one terminal to another.

CAUTION: This will reset all programmed information, setting the machine back to the factory default settings

This will reset the machine back to factory settings, ready to commence program. There are two options for resetting, the first will load default setting into the terminal, ready to commence programming. The second will prompt for user input of the file sizes. The first option is ideal for setting up demonstrations, the second is normally used for custom installations

This will erase the existing ROM and Transmit a new flash ROM (which has been download from the P.C.) down the IRC network

TO PREPARE RECEIVING TERMINAL

1. Turn the power switch located on the right side of the register to the OFF position.
2. Turn the key lock to the **S-MODE** position (one position clockwise from the PGM key lock position).
3. Press and hold the key position where the **CASH** key is located on the default keyboard layout.
4. Continue to hold the **CASH** key whilst turning the power switch to the ON position. (see figure 1)
5. Press each of the four corner keys TOP LEFT, BOTTOM LEFT, TOP RIGHT, BOTTOM RIGHT (see figure 2)
6. The screen will say download and is now waiting for the download procedure to be activated on the transmitting terminal.

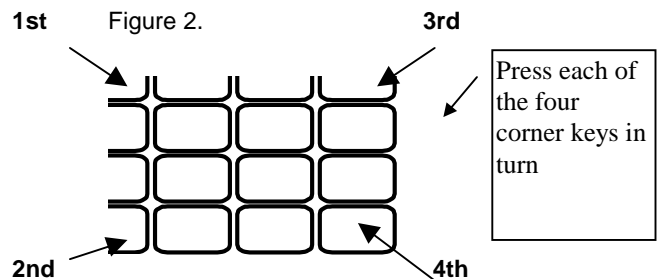
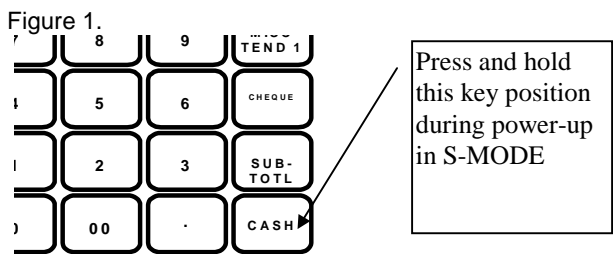

PC- FLASH ROM DOWNLOAD

TO TRANSMIT FROM THE PC

PC ROM ERASE

- Using the PC Flash ROM Directory
- Type **G_ERA** then press ENTER
- Enter the port number for the PC then press ENTER
- Then Enter 5 (or given alternative) then Press ENTER

The ROM is erased from the terminal this takes approximately 7 seconds

PC ROM DOWNLOAD

- Using the PC Flash ROM Directory
- Type **G-DOWN** the press ENTER
- Enter the port number for the PC then press ENTER
- Enter the file name **FROM.BIN** (or given alternative) then press ENTER
- Enter 0xc20000 (**zero ,X, C, two, zero, zero, zero, zero**) (or given alternative) then press ENTER

Note Once the ROM has been successfully downloaded reset the terminal using the S-MODE all program reset procedure.

It is possible to send the ROM to all terminals within the system using the ROM DOWNLOAD P-MODE option.



APPENDIX - WIRING

CAUTION:

SAMSUNG WIRING SPECIFICATIONS MUST BE ADHERED TO AT ALL TIMES

Always use ferrite cores supplied with register, these should be connected around the cable 250mm from the serial port on the register

WIRING SPECIFICATIONS – SCANNERS

ZEEBEK SCANNER

ZEEBEK SCANNER		SPS1000	
			9 PIN 'D' Type (Female)
Blue	TXD	_____	2 RXD
Red	CTS	_____	4 DTR
Yel/Blk	GND	_____	5 GND
White	+5V	_____	9 +5V

PROGRAMMING.	SETTINGS
Baud Rate	2400
Data Bits	8
Stop Bits	1
Parity	ODD

SYMBOL SCANNER

SYMBOL 1720 SCANNER		SPS1000	
			9 pin D type (female)
RED	TXD	_____	2 RXD
ORANGE	CTS	_____	4 DTR
BLACK	GND	_____	5 GND
BROWN	+ 5v	_____	9 + 5v

PROGRAMMING.	SETTINGS
Baud Rate	2400
Data Bits	8
Stop Bits	1
Parity	ODD

WIRING SPECIFICATIONS – SCANNERS

METROLOGIC MS700 SCANNER

<p>Metrologic MS700 Scanner 25 Pin D Type (female)</p> <p>TXD 3 _____ GND 7 _____</p>	<p>SPS1000 9 Pin D Type (Female)</p> <p>2 RXD 5 GND</p>
--	--

PROGRAMMING.	SETTINGS
Baud Rate	9600
Data Bits	7
Stop Bits	1
Parity	ODD

METROLOGIC MS951 SCANNER

<p>METROLOGIC MS951</p> <p>GREEN TXD BROWN GND ORANGE + 5v</p>	<p>SPS1000 9 Pin D type (Female)</p> <p>Pin 2 Pin 5 Pin 9</p>
---	--

PROGRAMMING.	SETTINGS
Baud Rate	2400
Data Bits	8
Stop Bits	1
Parity	ODD

WIRING SPECIFICATIONS – PRINTERS

PRINTER ALL SAMSUNG MODELS

SPS1000		PRINTER
9 Pin 'D' type (female)		25 Pin 'D' Type (male)
TXD 3	_____	3 RXD
RXD 2	_____	2 TXD
DSR 6	_____	20 DTR
CTS 8	_____	
DTR 4	_____	6 DSR
SG 5	_____	7 SG

RJ45- PRINTER ALL SAMSUNG MODELS

SPS1000		PRINTER
8 Pin Modular		25 Pin 'D' Type (male)
TXD 3	_____	3 RXD
RXD 4	_____	2 TXD
DSR 2	_____	20 DTR
CTS 6	_____	
DTR 8	_____	6 DSR
SG 7	_____	7 SG

WIRING SPECIFICATIONS – PC

TO P.C (VIA MODEM CONNECTION)

SPS1000				Full Duplex Modem	
9 Pin "D" Type (Female)				25 Pin "D" type (Male)	
Frame Ground (Screen)					
TXD	3	_____		2	TXD
RXD	2	_____		3	RXD
RTS	7	_____		4	RTS
CTS	8	_____		5	CTS
DSR	6	_____		6	DSR
Signal Ground	5	_____		7	SignalGround
DCD	1	_____		8	DCD
DTR	4	_____		20	DTR

DIRECT CABLE TO PC

SPS1000				PC	
9 pin				9 pin	
D type (Female)				25 pin	
				D type (Female)	
RXD 2	_____	3 TXD	_____	2	TXD
TXD 3	_____	2 RXD	_____	3	RXD
GND 5	_____	5 GND	_____	7	GND

WIRING SPECIFICATIONS – PC RJ45

NOTE: PC RJ45 cable specification should only be used for distance less than 1m

(RJ45) DIRECT CABLE TO PC

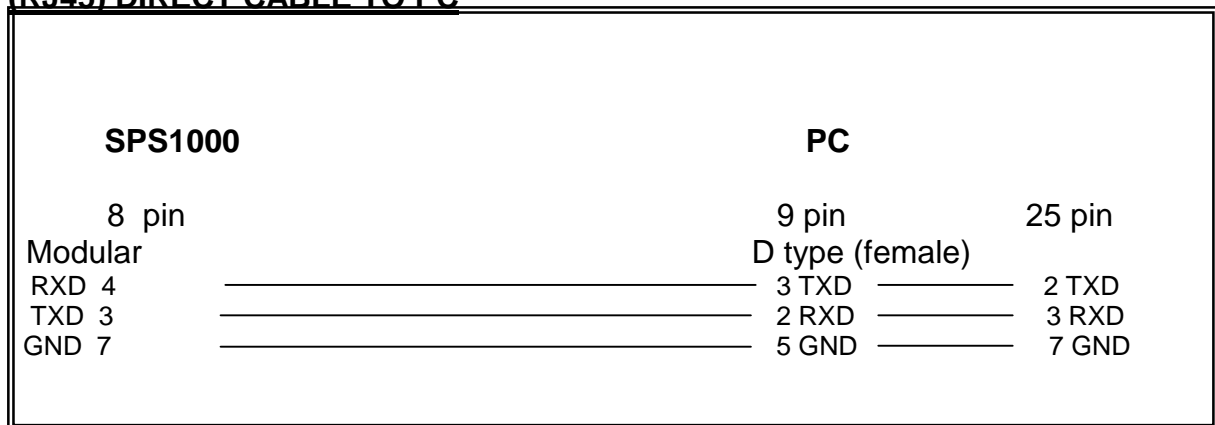

WIRING SPECIFICATIONS – IRC

TWO TERMINALS

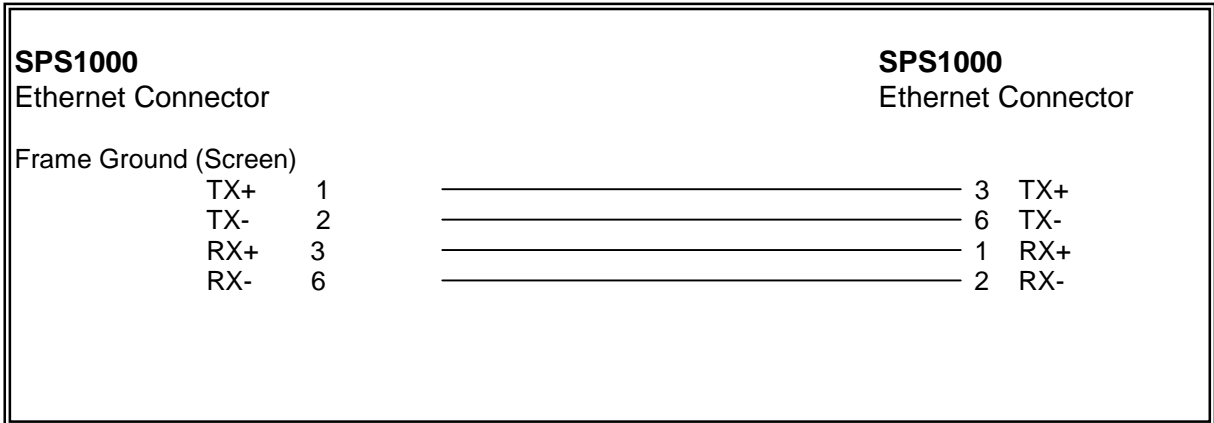

TO ETHERNET HUB

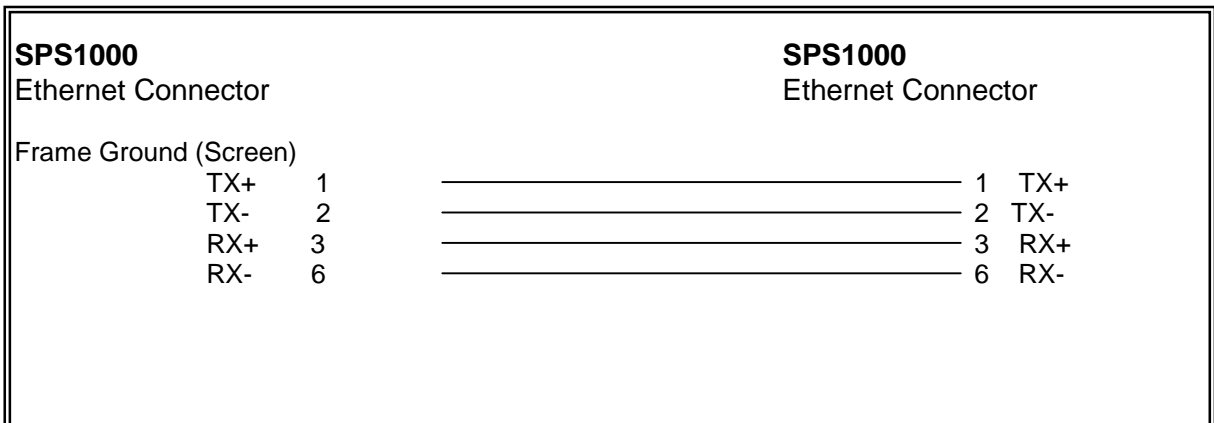

LOOP BACK CONNECTOR

If you want to test IRC, use the IRC test in self-test mode

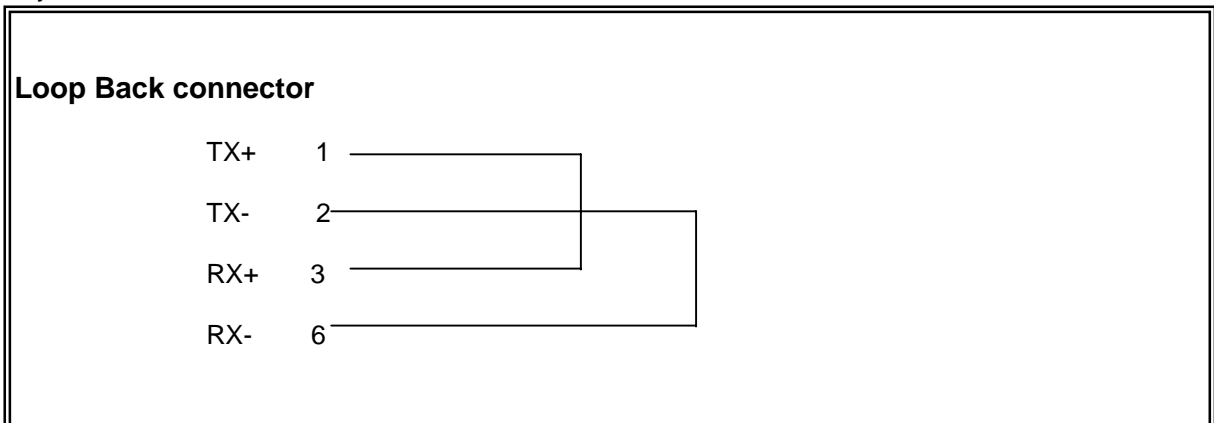

WIRING SPECIFICATIONS – PERIPHERALS

SAMSUNG POLE DISPLAY

SPS1000	POLE DISPLAY
3 RXD _____	RED
5 CTS _____	BLUE
9 _____	WHITE
4 – 8 Shorted	

EPSON DP101 / DP102 POLE DISPLAY

SPS1000	DP101/102 Pole Display
9 pin D type (female)	25 pin D type (male)
TXD 3 _____	3 RXD
GND 5 _____	7 GND
CTS 8 _____	20 DTR

NOTE: the following dip switch setting for the pole display are required to be on the epsom switch 1,5, 8

WIRING SPECIFICATIONS – PERIPHERALS

PORT LOCATIONS

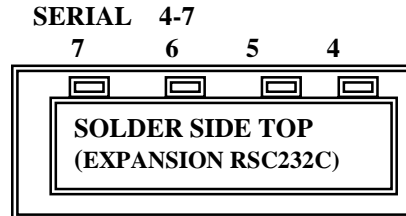
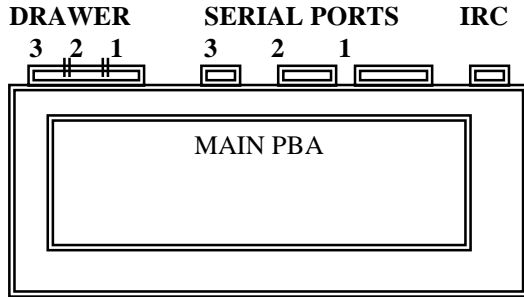

RS232.IRC AND CASH DRAWER PIN LOCATIONS

SERIAL 1,2 (D-Sub Male)

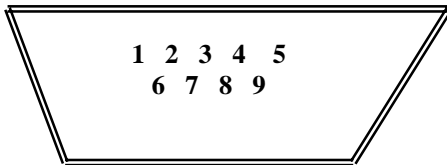

SERIAL 3-7, IRC (RJ45)

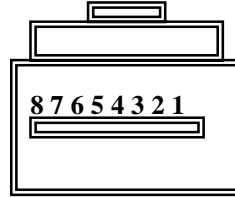

CASH DRAWER 1-3 (RJ11)



PIN#	SERIAL PORT 1	SERIAL PORT 2	SERIAL PORT 3	SERIAL PORT 4-7	IRC PORT	DRAWR PORT 1	DRAWR PORT 2	DRAWR PORT 3
1	/DCD	NC	Vcc	NC	TPTX+	FGND	FGND	FGND
2	RxD	RxD	/DSR	/DSR	TPTX-	SELON OID (-1)	SELONI OD (-)	SELONI OD (-1)
3	TxD	TxD	TxD	TxD	TPRX+	COMP1	COMP2	COMP3
4	/DTR	/DTR	RxD	RxD	NC	24V	24V	24V
5	GND	GND	NC	NC	NC	SELONI OD (-)	SELONI OD (-)	SELONI OD (-1)
6	/DSR	/DSR	NC	NC	TPRX-	GND	GND	GND
7	/RTS	/RTS	GND	GND	NC	RJ-11 (MODULAR 6 PIN)		
8	/CTS	/CTS	/DTR	/DTR	NC			
9	Vcc	Vcc	RJ-45 (MODULAR 8 PIN)					
CONN.	D-DUB9 (MALE)							



USER NOTES